

# PosiTector<sup>®</sup> **UTG**

## Ultrasonic Thickness Gage

Full Guide v. 3.1



**DeFelsko<sup>®</sup>**

## Table of Contents

Introduction .....	1
Quick Start .....	1
Certification .....	3
Probes .....	4
How to Measure .....	6
Surface Conditions .....	7
Calibration, Verification and Adjustment .....	8
Menu Operation .....	9
Cal Settings Menu .....	10
Zero .....	10
Thickness .....	11
Material .....	11
Velocity .....	11
2 Pt Adjust .....	12
Cal Lock .....	12
Cal Reset .....	12
Setup Menu .....	13
Reset .....	13
Min Scan .....	14
A Scan .....	14
B Scan .....	15
SE Mode .....	16
Smart Couple™ .....	17
Statistics Mode .....	19
Memory Management .....	20
Annotate .....	23
Summaries .....	25
Screen Capture .....	25

Assessing Stored Measurement Data .....	26
PosiSoft Desktop Manager (PDM) .....	26
PosiSoft.net .....	27
PosiSoft 3.0 .....	27
PosiSoft Mobile .....	28
Connect Menu .....	29
Sync Now .....	29
Auto Sync .....	29
USB Drive .....	29
Bluetooth .....	31
Bluetooth Wireless Printer .....	32
Updates .....	35
Application Notes .....	36
Measuring on pipes .....	36
Measuring on rough surfaces .....	36
Measuring on hot surfaces .....	37
Measuring laminated materials .....	37
Troubleshooting - General.....	38
Gage fails to power down.....	38
Probe measures when lifted from surface.....	38
Gage is coupled but not measuring.....	38
Gage readings double expected thickness	38
Measurement jumps when probe is lifted	38
Troubleshooting - Multiple Echo (M) probes.....	39
Power Supply / Battery Indicator .....	42
Rechargeable Batteries .....	42
Technical Data .....	44
Probe Details & Specifications.....	44
Operating Temperature Range.....	44
Size / Weight.....	44
Returning For Service .....	45
Warranty .....	45

# Introduction

The **PosiTector UTG** is a hand-held Ultrasonic Thickness Gage that uses the non-destructive ultrasonic pulse-echo principle to measure the wall thickness of a wide variety of materials. It consists of a body (*Standard* or *Advanced*) and probe (*UTG C* or *UTG M*, see pg. 4).

## PosiTector UTG Kit Contents

- PosiTector body (*Standard* or *Advanced*)
- PosiTector probe (*UTG C* or *UTG M*)
- Protective rubber cap for Probe
- Protective lens shield
- Wrist strap
- 3 AAA alkaline batteries
- Quick Guide instruction booklet
- Protective rubber holster
- Nylon carrying case with shoulder strap
- Belt clip for rubber holster and carrying case
- USB Cable
- 4 ounce (118 ml) bottle ultrasonic couplant
- Certificate of Calibration traceable to NIST
- PosiSoft.net account
- Two (2) year warranty on Body and Probe

## Quick Start

The **PosiTector UTG** powers-up when the center navigation button  is pressed. To preserve battery life, the instrument powers down after approximately 5 minutes of no activity. All settings are retained.

1. Remove the protective rubber cap from the probe.
2. Power-up Gage by pressing the center navigation  button.
3. Zero the probe (see pg. 10)
4. Select the correct velocity of sound (see pg. 11)
5. Measure the part (see pg. 6)

## Protective Cap

**PosiTector UTG** gages ship with a protective plastic cap over the probe. Remove this cap prior to use. Replace it when the instrument is not in use to protect the probe.

## Wrist Strap

We recommend attaching and wearing the supplied wrist strap.

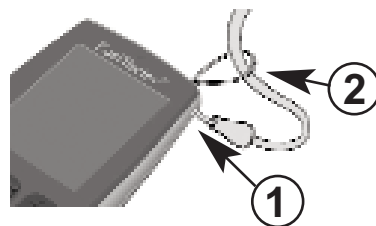

## Protective Lens Shield

The LCD is covered with a thin plastic film for protection against fingerprints and other marks during shipment. This film, while usually removed before using the instrument, can be left in place to protect against paint overspray or debris. Replacements can be purchased.

### PosiTector Body

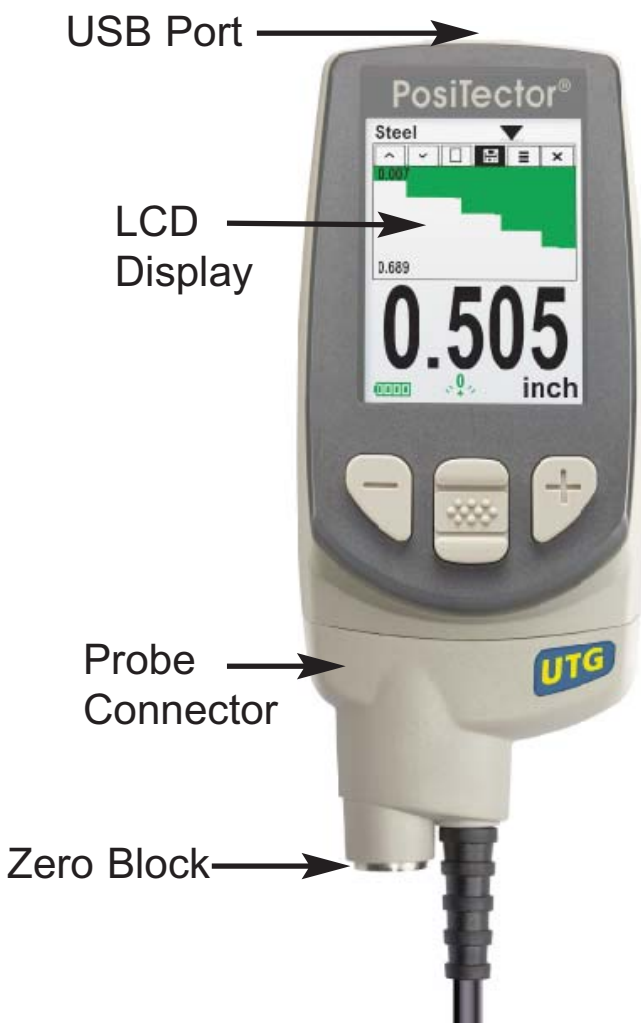

### UTG C probe



### UTG M probe



## Typical Display

The Coupled Symbol appears when the probe is ultrasonically connected with a surface.

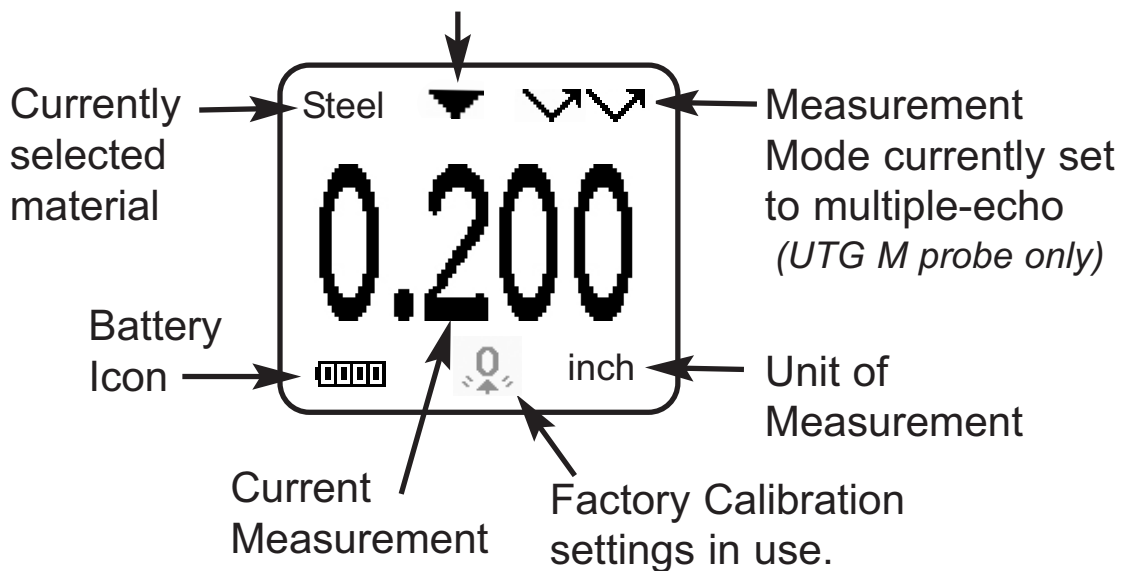

## **Certification**

All **PosiTector UTG** probes include a Certificate of Calibration. For organizations with re-certification requirements, instruments may be returned at regular intervals for calibration.

DeFelsko recommends that customers establish calibration intervals based upon their own experience and work environment. Based on our product knowledge, data and customer feedback, a one year calibration interval from either the date of calibration, date of purchase, or date of receipt is a typical starting point.

## Probes

To disconnect a probe from a body, power-down the instrument and slide the plastic probe connector horizontally (in the direction of the arrow) away from the body. Reverse these steps to attach a new probe.



When powered-up, the **PosiTector** automatically determines what type of probe is attached and does a self-check.

### Ultrasonic Thickness Probes - Theory of Operation

**PosiTector UTG** probes transmit an ultrasonic pulse into the material to be measured. This pulse travels through the material towards the other side. When it encounters an interface such as air (back wall) or another material, the pulse is reflected back to the probe. The time required for the pulse to propagate through the material is measured by the Gage, represented as  $t_1$  and  $t_2$  below.

**PosiTector UTG C** and **UTG M** (in single-echo  mode) probes determine thickness by measuring  $t_1$  (uncoated) or  $t_2$  (coated), dividing it by two and then multiplying by the velocity of sound for that material (steel). See Figure 1.

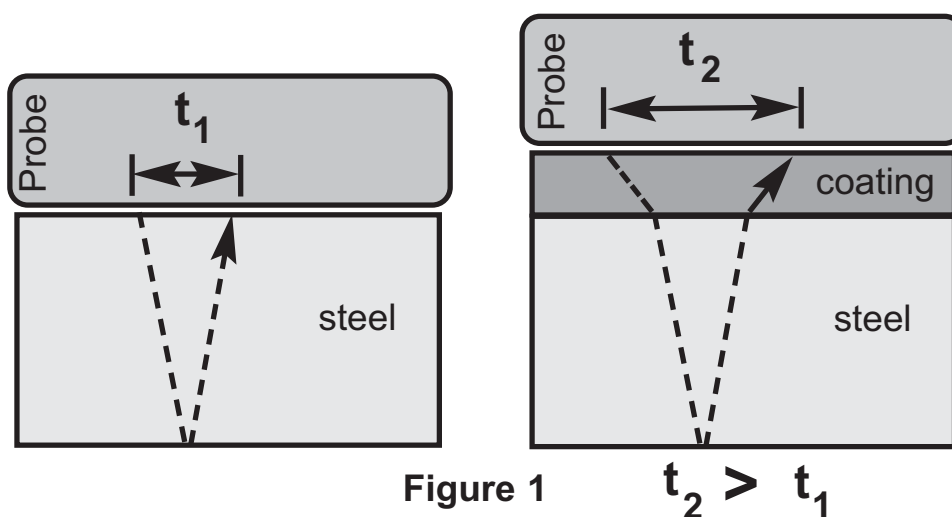

For uncoated materials  $t_1$  relates directly to material thickness. When a material is coated the propagation time is increased and is shown above as  $t_2$ .

Coatings such as paint have a slower velocity of sound than that of metal. Thus the single-echo technique will produce a thickness result greater than the actual combined coating+metal thickness.

The **PosiTector UTG M** in multiple-echo mode  determines thickness by measuring the time between at least three consecutive back wall echoes.

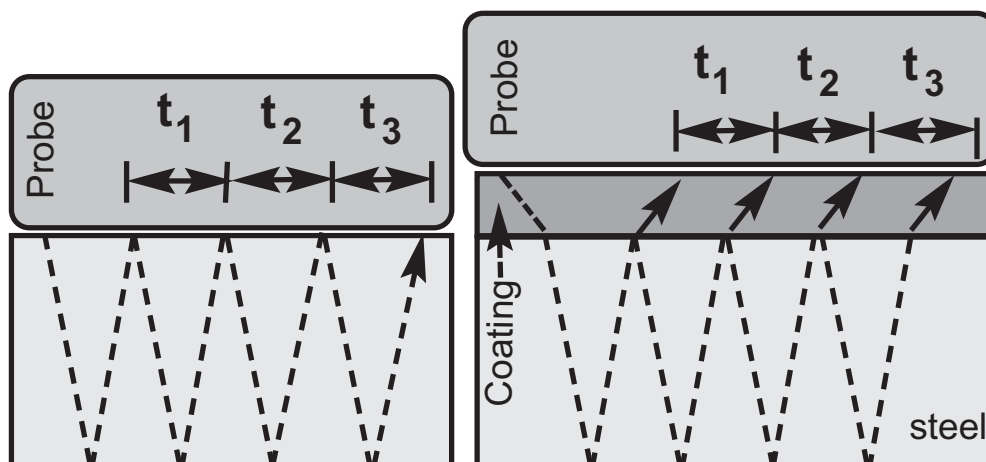

Figure 2

In the figure above, multiple-echo mode measures only the time between echoes. Regardless of whether the steel is coated or not, all times between echoes are the same. In multiple-echo mode, the Gage determines thickness by measuring  $t_1+t_2+t_3$ , dividing it by six and then multiplying by the velocity of sound for that material. The resultant thickness calculation made by the instrument is therefore an accurate measurement of the steel thickness only, disregarding the coating thickness.

The velocity of sound is expressed in inches per microsecond or meters per second. It is different for all materials. For example, sound travels through steel faster ( $\sim 0.233$  in/ $\mu$ s) than it travels through plastic ( $\sim 0.086$  in/ $\mu$ s).

Additionally, the **PosiTector** accepts a number of probe types including magnetic and eddy current coating thickness, surface profile, environmental and ultrasonic wall thickness probes. Perform the latest software **Updates** (pg. 35) to ensure probe compatibility with your Gage. For the latest information on probe interchangeability see [www.defelsko.com/probes](http://www.defelsko.com/probes)





## How to Measure

1. Remove rubber cap from probe. Couplant (glycol gel - included) must be applied to the surface to be tested to eliminate air gaps between the wear face and the surface. A single drop of couplant is sufficient when taking a spot measurement.

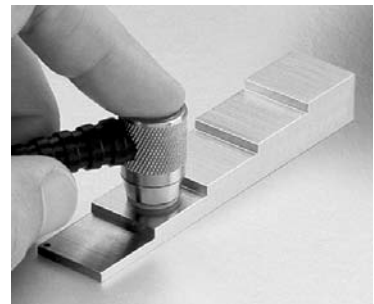

2. Place the probe flat on the surface. Use moderate pressure to press against the top of the probe with the thumb or index finger. When the probe senses echoed ultrasound, a coupled symbol  will appear on the display and thickness values will be displayed. While the probe is coupled, the **PosiTector UTG** continually updates the display.

3. When the probe is removed from the surface, the last measurement will remain on the display.

Occasionally, excess couplant will remain on the probe when the probe is lifted from the surface. This may cause the **PosiTector UTG** to display a final measurement value different from those observed when the probe was on the surface. Discard this value and repeat the measurement.

## Surface Conditions

Ultrasonic measurements are affected by the condition, roughness and contour of the surface to be tested.

Measurement results may vary on coarse surfaces. Where possible, it is recommended to seat the transducer on a smooth flat surface that is parallel to the opposite side of the material.

On rough surfaces, the use of a generous amount of couplant minimizes the surface effects and serves to protect the transducer from wear, particularly when dragging the probe across a surface.

During scanning operations, the probe can become physically decoupled, that is physically separated, from the material, either due to the rough and/or scaly surface of the material or due to user operation. Avoid this by using the **Smart Couple™** feature (pg. 17)

**UTG M Probes:** On smooth, uncoated metal surfaces the Gage (in multiple-echo mode) may occasionally be unable to give a measurement result even when the "coupled" symbol  appears. Use additional couplant and lighter pressure on the probe when measuring. Alternatively, laying a plastic shim on the surface with couplant applied to both sides to simulate a painted surface will help produce a steel-only thickness measurement (multiple-echo mode). Switching the Gage to single-echo **SE mode** (pg. 16) will also help produce a steel-only thickness measurement.

# Calibration, Verification and Adjustment

Three steps ensure best accuracy...

1. **Calibration** - typically done by the manufacturer or a qualified lab. All probes include a Certificate of Calibration
2. **Verification of Accuracy** - as done by the user on known reference standards such as calibration step blocks.
3. **Adjustment** - to a known thickness or sound velocity for the material to be measured

## Calibration

Calibration is the controlled and documented process of measuring traceable calibration standards and verifying that the results are within the stated accuracy of the Gage. Calibrations are typically performed by the Gage manufacturer or by a certified calibration laboratory in a controlled environment using a documented process. The standards used in the calibration are such that the combined uncertainties of the resultant measurement are less than the stated accuracy of the Gage.

Written Calibration Procedures are available online at no charge  
<http://www.defelsko.com/downloads.htm>

## Verification

Gage accuracy can and should be verified using known reference standards of the material to be tested.

Verification is an accuracy check performed by the user using known reference standards. A successful verification requires the Gage to read within the combined accuracy of the Gage and the reference standards.

To guard against measuring with an improperly adjusted Gage, verify the Gage at the beginning and the end of each work shift. During the work shift, if the Gage is dropped or suspected of giving erroneous readings, its accuracy should be re-verified.

In the event of physical damage, wear, high usage, or after an established calibration interval, the Gage should be returned to the manufacturer for repair or calibration.

### Adjustment

*Adjustment*, or *Calibration Adjustment* is the act of aligning the Gage's thickness readings to match that of a known reference sample. See **Calibration Adjustment** pg. 10.

## Menu Operation

Instrument functions are menu controlled. To access the Menu, power-up the instrument, then press the center navigation button.

Below is a sample menu for a **PosiTector UTG** Advanced model:

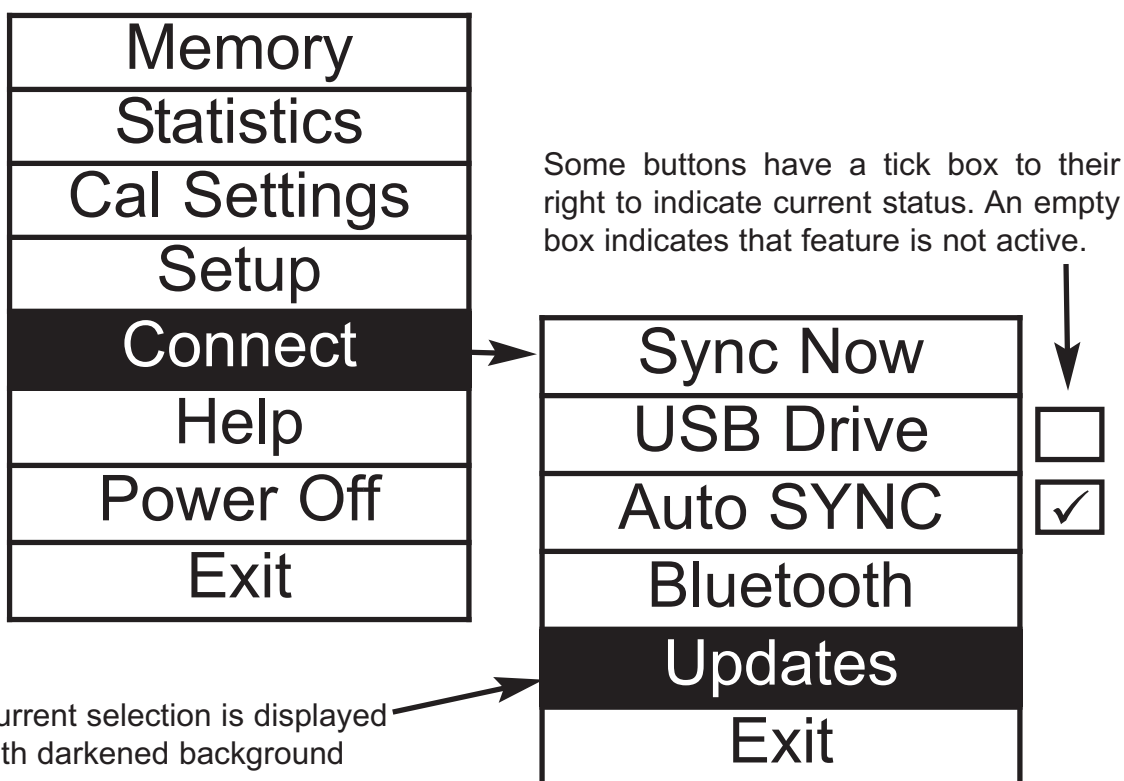

#### Navigation Button

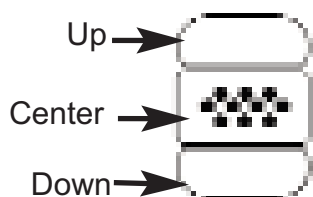

To navigate, use the **Up** and **Down** buttons to scroll and  to **SELECT**.

Select **Exit** to exit from any menu.

The center  button is purposely recessed to help eliminate unintentional powering-up of the instrument.

## Cal Settings Menu

### Zero

**PosiTector UTG** probes can be "zeroed" to compensate for temperature and wear. This action is not required when operating in multiple echo mode (*UTG M probes only*) except when the instrument is new and after a **Reset** (pg. 13). However, it ensures best accuracy when operating in SE (single-echo) mode. Therefore, it is a good idea to "zero" the probe before each work shift and when the temperature of the part changes. During zeroing, it does not matter what the current velocity setting is.

1. Make sure the instrument is on and the probe is wiped clean.
2. Apply a single drop of couplant **onto the zero plate** located on the underside of the probe connector. **DO NOT** apply couplant directly onto the probe face.
3. Select the **Zero** menu option and follow the on-screen prompts.

### Calibration Adjustment

The **PosiTector UTG** is factory calibrated. In order for it to take accurate thickness measurements of a particular material it must be set to the correct sound velocity for that material. Be aware that material composition (and thus its sound velocity) can vary from stated tables and even between lots from a manufacturer. Adjustment to a sample of known thickness of the material to be measured ensures that the Gage is adjusted as close as possible to the sound velocity of that specific material. Samples should be flat, smooth and as thick as the maximum expected thickness of the piece to be tested.

The **PosiTector UTG** allows four simple adjustment choices. All four methods are based on the simple premise of adjusting the sound velocity. The first three adjustment methods make 1-point calibration adjustments to optimize the linearity of the **PosiTector UTG** over small ranges. The fourth method makes a 2-point calibration adjustment to allow for greater accuracy over a large range.

## Thickness

The most common method of adjustment is to measure a sample of known thickness. Select a reference standard of material as close as possible in composition to the intended application. For best results, the thickness of the reference standard should be equal to or slightly greater than the thickness of the part to be measured.

1. Apply a drop of couplant onto the reference standard.
2. Measure the reference standard.
3. Lift the probe. Select **Thickness** from the **Cal Settings** menu.
4. Adjust the display down (-) or up (+) to the reference thickness.
5. Press  to store the adjustment and exit.

## Material

If a known thickness of the material is not available, but the material is known, this quick adjustment allows the user to load one of several preprogrammed material velocities.

1. Select **Material** from the **Cal Settings** menu.
2. Navigate to the desired material
3. Press  to select and exit.

### Pre-programmed Material Velocities

Material (Menu Option)	Longitudinal Velocity		Min Range*		Max Range*	
	in/us	m/s	in	mm	in	mm
CAST IRON (Iron)	0.179	4547	0.040	1.02	5.000	127.00
SS 303 (SS303)	0.223	5664	0.040	1.02	5.000	127.00
STEEL 1018 (Steel)	0.233	5918	0.040	1.02	5.000	127.00
Al 2024 (Alum)	0.251	6375	0.050	1.27	5.000	127.00
PLEXIGLAS (Plexi)	0.106	2692	0.040	1.02	2.000	50.80
PVC (PVC)	0.094	2388	0.035	0.89	2.000	50.80
POLYSTYRENE (Poly)	0.081	2057	0.035	0.89	2.000	50.80

\* Range may change depending on surface roughness, Temperature or Material Properties.



## Velocity

If the sound velocity for the test material is known, the Gage can be adjusted to that specific sound velocity

1. Select **Velocity** from the **Cal Settings** menu.
2. Adjust the display down (-) or up (+) to the desired velocity.  
Holding the (-) or (+) buttons increases the rate of change.
3. Press  when the desired velocity is reached.

## **2 Pt Adjust**

A 2-Point adjustment allows for greater accuracy while simultaneously adjusting probe zero. Select two reference standards as close as possible in composition to the intended application. For best results, the thickness of the thicker reference standard should be equal to, or slightly greater than the thickest part to be measured. The thickness of the thinner reference standard should be as close as possible to the lower end of the expected measurement range.

1. Select **2 Pt Adjust** from the **Cal Settings** menu.
2. Measure the thinner reference sample.
3. Lift the probe from the sample and adjust the display down (-) or up (+) to the expected thickness.
4. When the expected thickness is reached, press .
5. Measure the thicker reference sample.
6. Lift the probe from the reference sample and adjust down (-) or up (+) to the expected thickness.
7. Press  to store the adjustment and exit.

## **Cal Lock**



When checked, the  icon appears and the current Cal settings are “locked” to prevent further user adjustments. Uncheck to make further adjustments.

## **Cal Reset**

Clears all user calibration adjustments and returns the **Material** back to Steel. The factory calibration icon  is displayed.



# Setup Menu

## Reset

**Reset** (soft reset) restores factory settings and returns the instrument to a known condition. The following occurs:

- All batches, stored measurements, images, and batch names are erased.
- All calibration adjustments are cleared and returned to the Gage's factory calibration  settings.
- Menu settings are returned to the following:

<b>Memory</b> = OFF	<b>A Scan</b> = OFF	<b>Display</b> = None
<b>Statistics Mode</b> = OFF	<b>B Scan</b> = OFF	<b>SE Mode</b> = OFF
<b>Hi Lo Alarm</b> = OFF	<b>Cal Lock</b> = OFF	<b>Smart Couple</b> = OFF
<b>Min Scan</b> = OFF	<b>Bluetooth</b> = OFF	

Perform a more thorough **Hard Reset** by powering down the instrument, waiting several seconds, then simultaneously holding both the center  and **(+)** buttons until the **Reset** symbol  appears. This returns the instrument to a known, “out-of-the-box” condition. It performs the same function as a menu **Reset** with the addition of:

- Bluetooth Pairing info is cleared.
- Menu settings are returned to the following:

<b>Units</b> = millimeter	<b>Battery Type</b> = Alkaline
<b>Flip Display</b> = Normal	<b>Backlight</b> = Normal
<b>Auto Sync</b> = OFF	<b>Bluetooth Streaming</b> = OFF
<b>White on Black</b> = OFF	<b>USB Drive</b> = ON
<b>Language</b> = English	

**NOTE:** Date and Time are not affected by either **Reset**.

## Gage Info

Displays the model number & serial number, probe type & serial number, PosiSoft.net registration key, the amount of remaining memory for storage of readings, date and time, and software packages.

For security purposes, the registration key is required to add the instrument to your PosiSoft.net account.



**Min Scan**

Normally, the **PosiTector UTG C** takes a single spot measurement at a rate of 6 readings per second while in contact with a surface. When the probe is lifted, the minimum reading thickness will remain on the display.

It is sometimes necessary to examine a larger region to locate the thinnest point. When **Min Scan** is selected, the **PosiTector UTG C** will measure at a rate of 20 readings per second and display min/max values.

The **PosiTector UTG M** measures at a rate of 4 readings per second when **Min Scan** is selected.

During scanning operations, the probe can become physically decoupled, that is physically separated, from the material, either due to the rough and/or scaly surface of the material or due to user operation. Avoid this by using the **Smart Couple™** feature (pg. 17)

**A Scan**

*(Advanced models only)*

A display in which the received pulse amplitude is represented along y axis and the travel distance of the ultrasonic pulse is represented along the x axis.

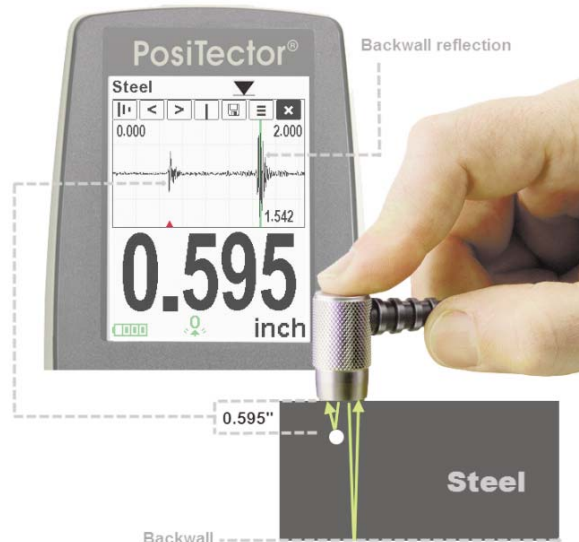
**A-Scan Menu**

Use the **Up** (move left) and **Down** (move right) buttons to navigate.

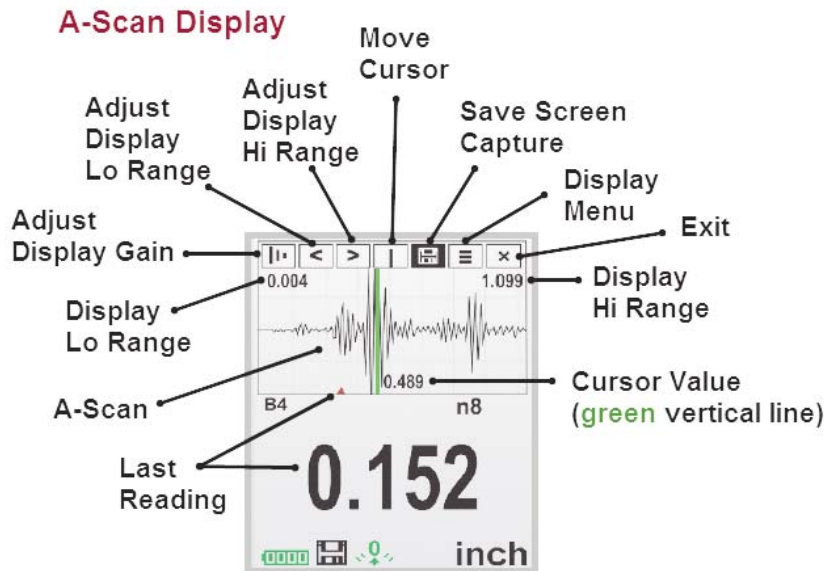

**Adjust Display Gain** - Adjusts the A-Scan amplitude/sensitivity. Use the (-)(+) buttons to decrease/increase gain.

**Adjust Display Lo/Hi Range** - Adjusts the minimum and maximum displayed range for the A-Scan. Use the (-)(+) buttons to decrease/increase gain. Note: This does not change the instruments measuring range.

**Move Cursor** - The Cursor allows for further analysis of the A-Scan. Use the (-)(+) buttons to move the cursor along the A-Scan.

**Save Screen Capture** - Press  to capture and save an image copy of the current display. The last 10 screen captures are stored in memory and can be accessed when connected to a computer (see **USB Drive** pg. 29).

**Display Menu** - Press  to display the Gage menu (pg. 9)

**Exit** - Press  to close the A-Scan display. Press the **Up** button to return to the A-Scan display.

**B Scan**  (Advanced models only)

A display in which a cross sectional profile view of the test material is represented.

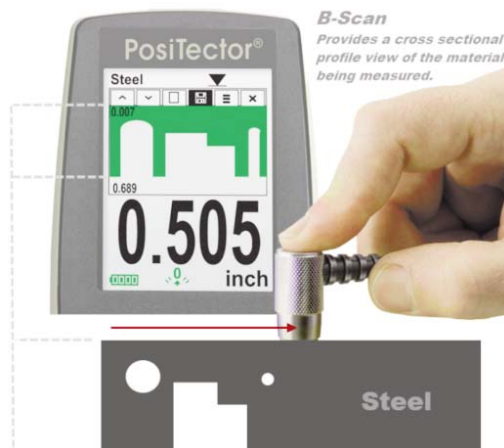

## B-Scan Menu

Use the **Up** (move left) and **Down** (move right) buttons to navigate.

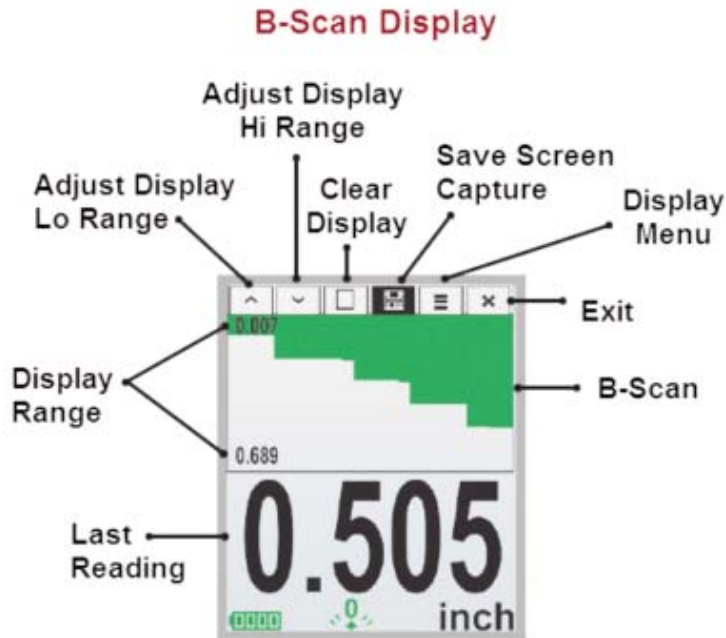

**Adjust Display Lo/Hi Range** - Adjusts the minimum and maximum displayed range for the B-Scan. Use the **(-)(+)** buttons to decrease/increase gain. Note: This does not alter the instruments measuring range.

**Clear Display** - Press  to clear the B-Scan display and start over.

**Save Screen Capture** - Press  to capture and save an image copy of the current display. The last 10 screen captures are stored in memory and can be accessed when connected to a computer (see **USB Drive** pg. 29).

**Display Menu** - Press  to display the Gage menu (pg. 9)

**Exit** - Press  to close the B-Scan display. Press the **Up** button to return to the B-Scan display.

**SE Mode**  (UTG M multiple-echo probes only)

Switches from multiple-echo  to single-echo  mode:

- To detect pits and flaws
- To increase the measurement range
- To obtain thickness measurements in circumstances where multiple-echo can not

**SmartCouple**



Coupled



Smart Coupled

When selected, the probe, once coupled, will remain coupled until the (+) button is pressed. Eliminates unintentional decoupling.

During scanning operations, the probe can become physically decoupled, that is physically separated from the material, either due to the rough and/or scaly surface of the material or due to user operation.

When this happens, analysis of the material stops and statistics are displayed for only that portion of the surface to which the probe was coupled. If the probe re-couples on purpose or accidentally, statistical values are reset to zero, and a new measurement analysis session begins.

Due to the physical decoupling of the probe, the Gage may output two or more independent measurement sessions. If the intention was to measure the maximum and minimum thicknesses continuously, erroneous indications may result due to the physical decoupling of the probe from the material.

**Smart Couple™** mode maintains a continuous measurement session regardless of whether the probe becomes physically decoupled from the material, and analyzes the thickness values of the material at all locations where the probe was coupled.

This mode of operation provides a number of advantages. For example, the user can make multiple passes between various points of a material to be measured, and not have to actively concentrate on ensuring that the probe is physically coupled to the material. The user can therefore focus on the material itself, rather than the instrument, or can focus more closely on the measurement results displayed on the display. In addition, it provides higher accuracy and faster scanning, since the user does not have to stop and record between different scanning operations. The user can deliberately lift the probe and scan a new area knowing that all results will be analyzed if it were from one continuous scan.

## Flip Display

This option causes the display to rotate 180°. Ideal for right-side-up viewing when the sensors are pointed away from the user.

## White on Black (Advanced models only)

Inverts the LCD display to white on a black background to provide better readability in some surroundings.

## Backlight

Selects display brightness (Advanced models only) (Sun, Normal or Night). All settings will dim slightly after a period of no activity to conserve battery life. Press the **Down** button to brighten the display.

## Set Clock

All measurements are date and time stamped (24 hour format) when stored into memory. It is therefore important to keep both the date and time current using this menu option. Use the **Up** and **Down** buttons to scroll, and the **(-)** and **(+)** buttons to adjust a value. The instrument's date and time can also be viewed in **Gage Info** (pg. 13).

## Battery Type

Selects the type of batteries used in the instrument from a choice of "Alkaline", "Lithium" or "NiMH" (Nickel-metal hydride rechargeable). If NiMH is selected, the instrument will trickle charge the batteries while connected via USB to a PC or optional AC charger (Gage must be powered ON). The battery state indicator icon is calibrated for the selected battery type. No damage will occur if the wrong battery type is selected.

DeFelsko recommends *eneloop* (NiMH) rechargeable batteries.

## Units

Converts the display from inch to metric or vice versa. Stored measurements in memory are not converted.

**NOTE:** Switching units will turn off Statistics, HiLo Alarm, and closes Memory.

## Language

Converts displayed and printed words to the selected language.

## Statistics Mode

### Statistics



A statistical summary will appear on the display. Remove the last measurement by pressing the (-) button. Press (+) to clear statistics.

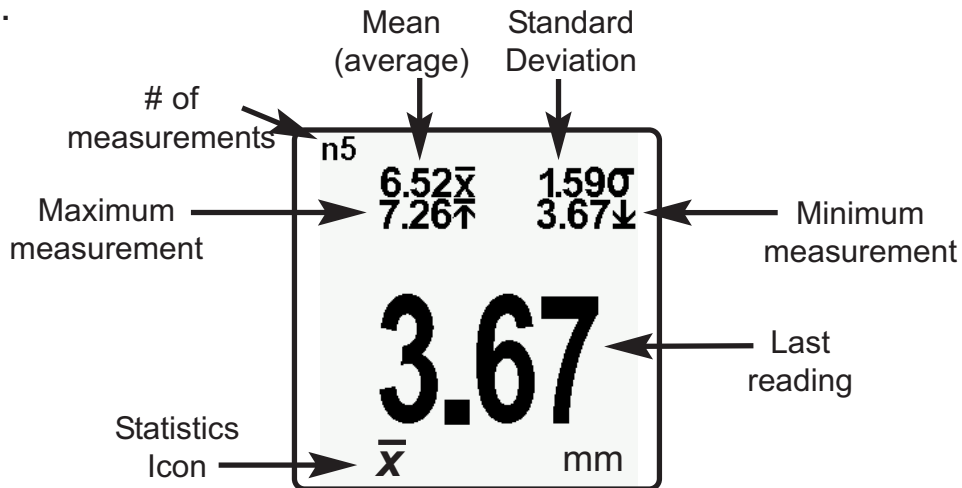

### HiLo Alarm



Allows the Gage to visibly and audibly alert the user when measurements exceed user-specified limits.

When **HiLo Alarm** is selected, the current **Lo** setting is displayed. Adjust down (-) or up (+). Alternatively, measure a material with a thickness close to the required value and make final adjustments with the buttons. Select **NEXT** to accept this value. The current **Hi** setting is now displayed. Follow the same procedure to adjust the **Hi** setting.

The  $\mathbb{H}$  icon will appear on the display.

Measurements will be compared to your defined **HiLo** limits. The Gage beeps if results are within those limits. A single low tone will sound if the reading is below the **Lo** limit, and a high tone if it is above the **Hi** limit. Press (+) to clear **HiLo** readings.

### Clear

Clears all onscreen **Statistics** and **HiLo** tabulations.

# Memory Management

The **PosiTector UTG** can record readings in memory for printing, transferring to a computer or synchronizing with *PosiSoft.net*. Readings are date and time stamped as they are taken.

Button functions with **Memory ON**:



**Standard models** store up to 250 readings in one batch.

The **Memory** Menu includes the following options...

On: turns memory on and begins recording

Off: stops recording (stored readings remain in memory)

Clear: removes all readings from memory

View: lists group statistics and all stored readings on the display. It will begin by showing statistics based on all readings in memory. Use the **Up** and **Down** buttons to scroll through all readings. Press  to exit.

Standard Model display with **Memory ON** shows measurement statistics:

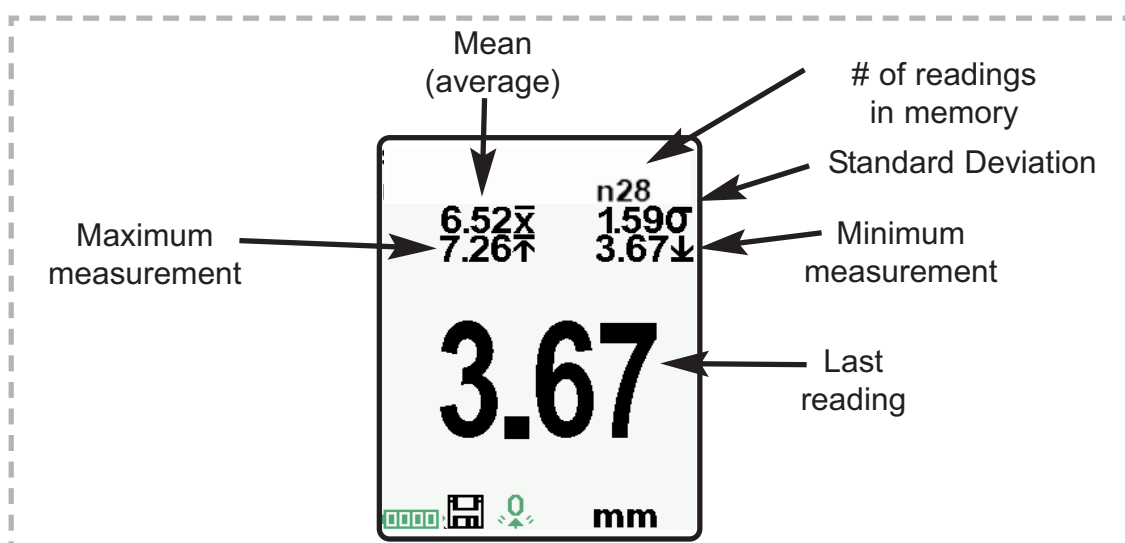

**Advanced models** store 100,000 readings in up to 1,000 batches. The **Memory** Menu includes the following options...

### New Batch

Closes any currently opened batch and creates a new batch name using the lowest available number. For example, if only **Batch 1** and **Batch 3** exist, then **Batch 2** would be created and made the current batch. The  icon appears and basic statistics are displayed. Each measurement will be displayed and stored into this new batch. On screen statistics are immediately updated with each measurement. New batch names are date stamped at the time they are created. Each reading is also data/time stamped.

**Shortcut:** When a batch is open, press **(+)** to create a new batch

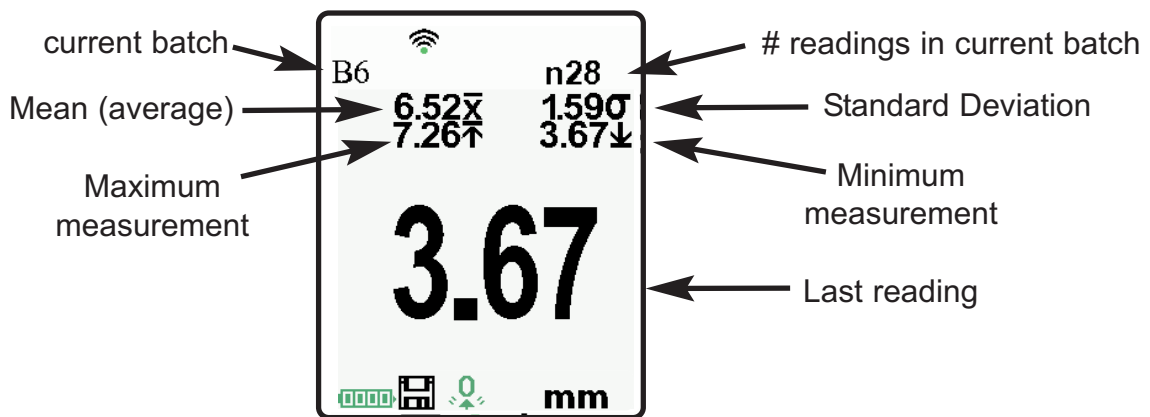

### NOTES:

- Remove the last reading from the current open batch by pressing **(-)**.
- Calibration adjustments cannot be made if readings are stored in memory.
- If memory is ON, continuous measurements can be taken but results will not be stored in memory.



## New Sub-Batch

(appears only if a batch is currently open)

Creates a new sub-batch within the currently opened batch.

**Shortcut:** When a sub-batch is open, create a new sub-batch by pressing (+).

In the following example, **B7s2** is a sub-batch of **Batch 7**. Sub-batching allows the user to group related batches so that statistics can be accumulated for them. **Batch 7** contains the statistics for **B7s1** and **B7s2**.

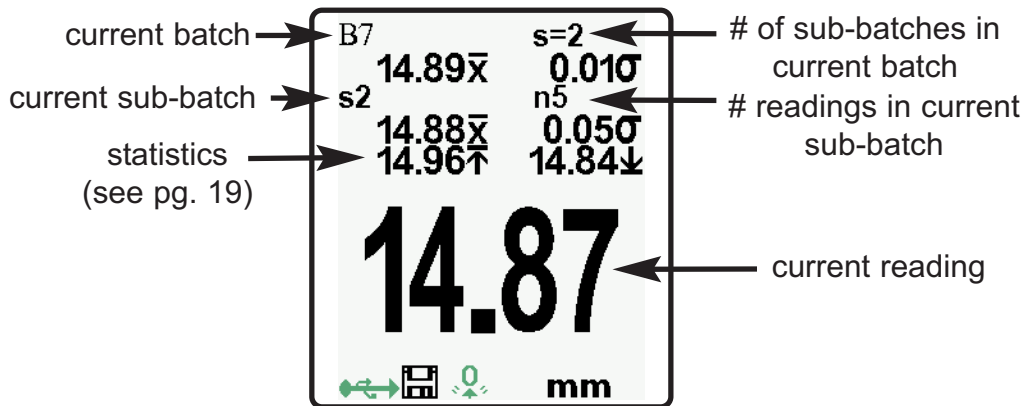

## Open

Selects a previously created batch or sub-batch name to open and make current. If it contains measurements, onscreen statistics will immediately reflect values calculated from this batch.

**NOTE:** A solid triangle **▶** is displayed to the right of the batch name when sub-batches are present. Press  to view sub-batches. This also applies to the *Delete*, *View* and *Print* options.

## Close

Stops the recording process, closes the current batch, and removes batch information from the display.

## Delete

Removes a batch or sub-batch completely from memory. The name is deleted and all measurements are erased. Sub-batches can be deleted individually.

To delete all related sub-batches, simply delete the top-level batch.

## View

Scroll using the **Up** or **Down** buttons through information, statistical summary, and a list of each reading in the currently opened batch.

Press  to exit.

## Annotate

Create meaningful batch names and enter notes directly on the Gage using a familiar onscreen *QWERTY* keyboard.

Use the Gage's navigation and **(-)(+)** buttons to enter annotations.

Annotations can be synchronized with PosiSoft.net and are included in all PosiSoft reports (see **Accessing Stored Measurement Data**, pg. 26).

**NOTE:** Annotations can also be created using PosiSoft.net (pg. 27) or PosiSoft Mobile (pg. 28).

## Print

Sends a statistical summary and individual measurements to the optional Bluetooth wireless printer (pg. 32).

**NOTE:** To cancel printing, press and hold the **(-)** and **(+)** buttons simultaneously.



## Display

(appears only if a batch is currently open)

The following user selectable display options are available:

 **Chart:** A real-time chart of batch readings

**x-y Chart**  
**A-Scan**

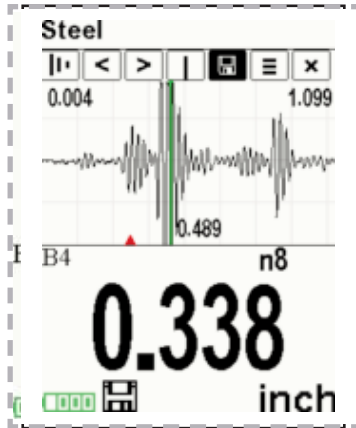

**Stack Chart**  
**B-Scan**

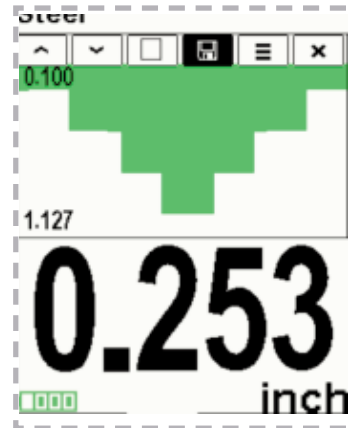

 **Image:** Batch image

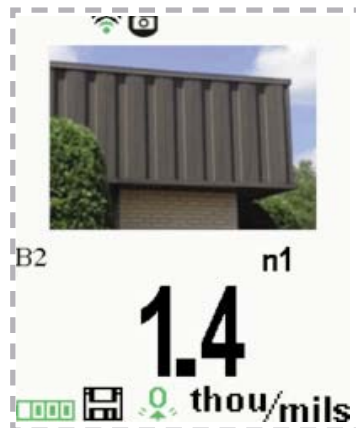

 **Notes:** Instructions, descriptions or notes (see Annotate, pg.20)

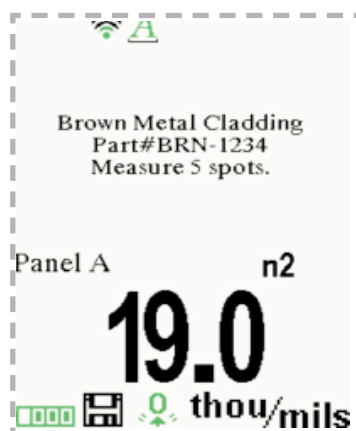

**None:** Default screen shows statistics

**Shortcut:** When a batch is open, press **Up** to scroll through the above display options.

**NOTE:** PosiSoft.net (pg. 27) and PosiSoft Mobile (pg. 28) are used to insert an **Image** and **Notes** into a batch.

**NOTES:** Remove the last reading from the current open batch by pressing (-).

Calibration adjustments cannot be made if any measurements were taken with that Cal setting and stored into a batch.

Each batch can contain a maximum of 10,000 readings.

### Summaries

(Advanced models only)

Displays a summary of all stored batches including the name, probe type, number of readings and type.

In the following example, Batch 3 (**B3**) indicates an “F” 6000 coating thickness probe was used to record a total of “6” readings in “PA2” mode.

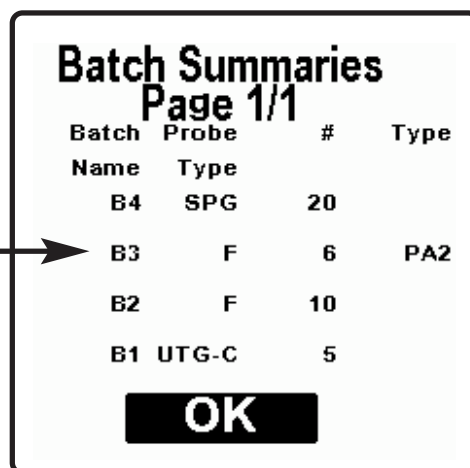

Batch Name	Probe Type	#	Type
B4	SPG	20	
B3	F	6	PA2
B2	F	10	
B1	UTG-C	5	

OK

### Screen Capture

Press both (-)(+) buttons at any time to capture and save an image copy of the current display. The last 10 screen captures are stored in memory and can be accessed when connected to a computer (see *PosiSoft USB Drive* pg. 29).

#### Sample Screen Captures

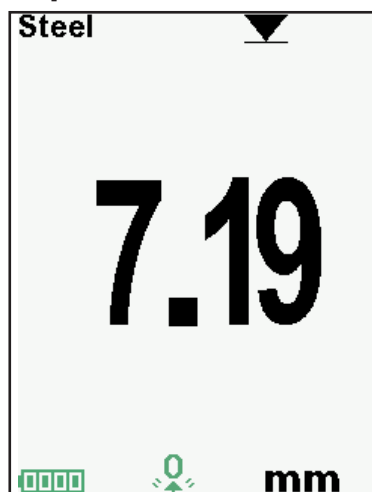
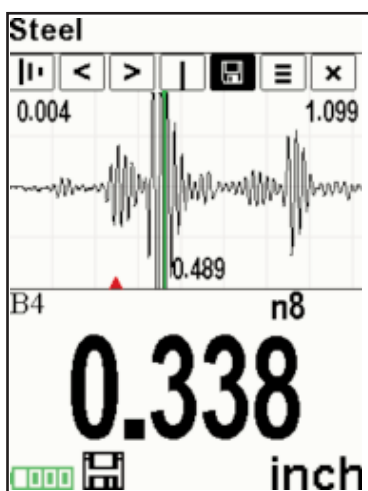

## Accessing Stored Measurement Data

PosiSoft solutions for viewing, analyzing and reporting data:

**PosiSoft USB Drive** - connect the **PosiTector** to a PC/Mac using the supplied USB cable to access and print stored readings, graphs, photos, notes and screen captures. No software or internet connection required. **USB Drive** must be selected (See pg. 29).



**PosiSoft.net** - a free web-based application offering secure centralized storage of **PosiTector** readings. Access your data from any web connected device. Go to: [www.PosiSoft.net](http://www.PosiSoft.net)

**PosiSoft 3.0** - Desktop Software for downloading, viewing and printing your measurement data.

**PosiSoft Mobile** (*Advanced models only*) - access readings, graphs, capture photos and update annotations through WiFi enabled devices, such as tablets, smart phones and computers.

### **PosiSoft Desktop Manager (PDM):**

A small Windows based application which allows automatic two-way communication (synchronization) between the Gage and *PosiSoft.net* (internet connection required). When installed, PDM runs as a start-up application and resides in the Windows notification area (system tray) of a PC. PDM is available as a free download within your PosiSoft.net account or at [www.defelsko.com/downloads](http://www.defelsko.com/downloads)

Register your Gage on PosiSoft.net to take full advantage of your Gage's capabilities. See [www.PosiSoft.net](http://www.PosiSoft.net)

**NOTE:** PDM is not required for **WiFi** enabled gages (pg. 32).

## PosiSoft.net:

To enhance the operation of your Gage, all **PosiTector** users have access to the features provided by *PosiSoft.net*. It is a web-based application offering secure centralized management of readings.

After (1) a user account has been created, (2) a Gage has been registered, and (3) the *PosiSoft Desktop Manager* is downloaded and installed onto a Windows PC (not required for WiFi connected gages), synchronization of measurement data can be performed either manually or automatically whenever the **PosiTector** is connected to a web enabled PC (USB cable or Bluetooth wireless technology) or WiFi network (Advanced gages only). Gage measurements stored in memory are uploaded; images and batch notes are synchronized.

Uploaded data can be manipulated using a standard internet web browser from any location in the world - job site or head office. Reports and graphs with annotations and corporate logo can be generated. Data can be exported to XML or CSV (comma delimited) text files.

Measurement data can be shared with authorized users via a secure login from any computer and most web enabled devices including smart phones.

**NOTE:** A *PosiSoft.net* account is not required to **Update** (pg. 35) your **PosiTector**. Simply download and install *PosiSoft Desktop Manager* at [www.defelsko.com/downloads](http://www.defelsko.com/downloads)

## PosiSoft 3.0:

Desktop Software that can be installed onto your Windows PC and allows the user to download, view, print and analyze their measurement data.

Reports and graphs with annotations and corporate logo can be generated. Data can be exported to XML or CSV (comma delimited) text files.

**NOTE:** *PosiSoft Software* is available for use with DeFelsko's complete line of electronic instruments and is available for download at [www.defelsko.com/posisoft](http://www.defelsko.com/posisoft)

## PosiSoft Mobile:

Is a Gage-based software application featured in all **PosiTector** Advanced instruments (serial numbers 730,000+).

PosiSoft Mobile allows users to:



- browse stored measurement data including notes, images, statistics and charts
- update batch names/notes using your mobile device's keyboard
- insert images directly into Gage batches using your mobile device's camera or image library
- remotely view the live display of a working **PosiTector** & more

PosiSoft Mobile can be accessed from any WiFi enabled device using a standard web browser.

Ideal for use with devices such as Windows Phone/Mobile, Blackberry (RIM), Android, Apple iOS and more.

In addition to browser based access, PosiSoft Mobile Managers are available for Apple iOS and Android users.

See [www.defelsko.com/wifi/wifi\\_mobile](http://www.defelsko.com/wifi/wifi_mobile)



## Connect Menu

**Synchronizing** (Sync) is the process whereby **PosiTector** stored measurement data uploads to *PosiSoft.net* (from both Standard and Advanced models) while images and batch notes are downloaded to the Gage (*Advanced model only*). This transfer occurs when the Gage is connected via USB, Bluetooth or directly through your WiFi router/hotspot via WiFi. It can be triggered either manually (USB, Bluetooth or WiFi) or automatically (USB only).

### **Sync Now**

When selected, the Gage immediately synchronizes stored measurement data via USB, Bluetooth or WiFi to *PosiSoft.net* (*internet connection required*). *PosiSoft Desktop Manager* (pg. 26) is required when using USB or Bluetooth.

Multiple gages can be synchronized simultaneously when connected using multiple connections (for example two gages connected via USB and one gage connected via WiFi or Bluetooth).

### **Auto SYNC**



Allows the Gage to automatically synchronize stored measurements with *PosiSoft.net* when initially connected via USB to an internet connected PC running *PosiSoft Desktop Manager* (pg. 26).

Additional measurements added to memory while connected are synchronized only when the USB cable is disconnected, then reconnected or when the **Sync Now** option is selected.

### **USB Drive**



Universal Serial Bus (USB) is a specification for communication between devices and a host controller (usually a personal computer). USB has effectively replaced a variety of interfaces such as serial and parallel ports.

The **PosiTector** uses a USB mass storage device class which provides a simple interface to retrieve data in a manner similar to USB flash drives, cameras or digital audio players.



When checked, any computer can view datasets stored in memory by navigating a virtual drive labeled “PosiTector” using the included USB cable.

A formatted HTML report is viewed by selecting the "index.html" or “START\_HERE.html” file found in the root directory. Optionally, text ".txt" files located in each batch folder provide access to measurement values. Stored datasets and graphs can be viewed or copied using universal PC/Mac web browsers or file explorers.

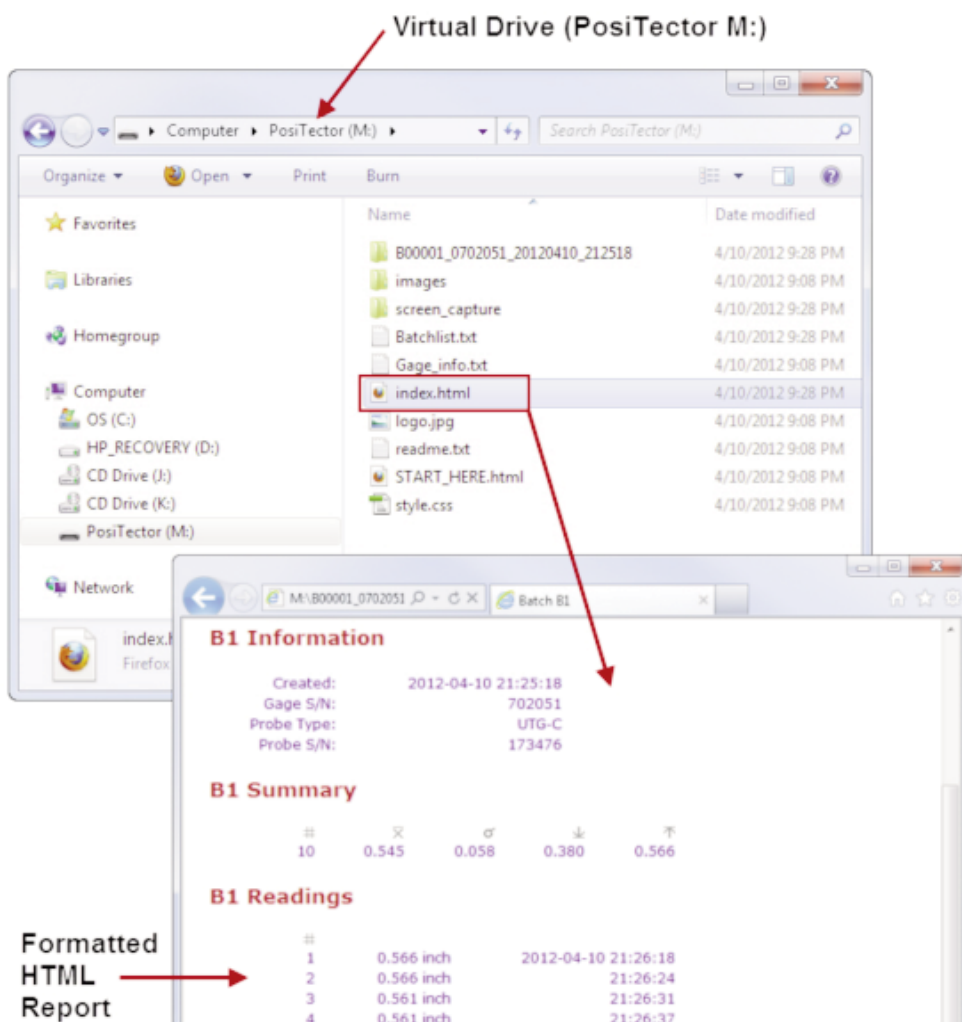

When your **PosiTector** is first connected to your Windows PC via a USB cable, an enumeration process is started that installs device drivers without re-booting your computer. You may see several pop-up windows in the taskbar at the bottom right of your screen. Wait for the entire process to be completed before proceeding.

**NOTE:** When connected, power is supplied through the USB cable. The batteries are not used and the body will not automatically power down. If rechargeable (NiMH) batteries are installed, the instrument will trickle charge the batteries.

## Retrieving stored screen captures

The last 10 screen captures (pg. 25) stored in memory can be accessed by navigating to the “screen\_capture” directory within the “PosiTector” virtual drive.

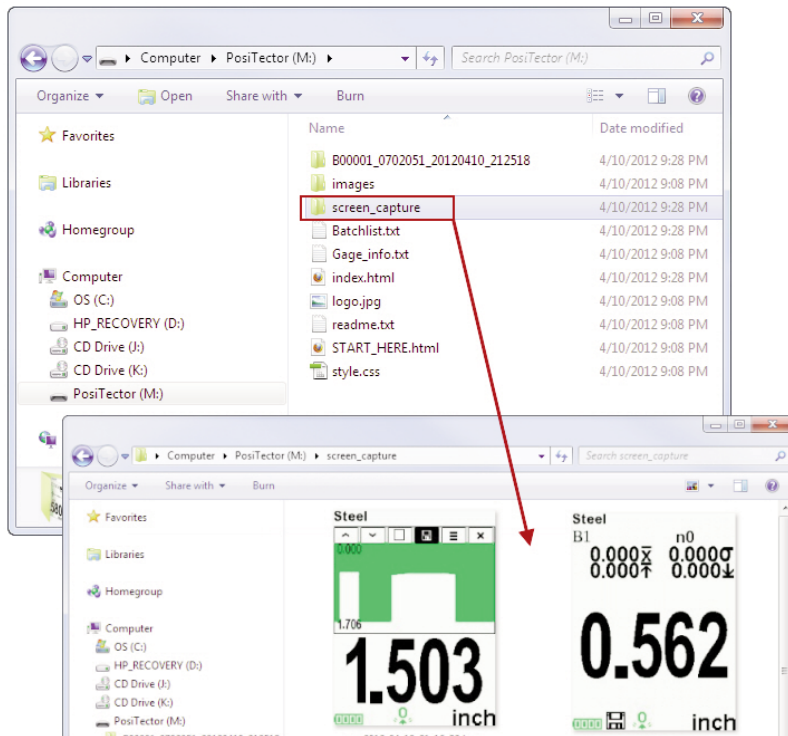

### Bluetooth

(Advanced models only)



**PosiTector** Advanced models have Bluetooth functionality to:

- **Communicate** with the *PosiSoft Desktop Manager (PDM)* in lieu of a USB cable.
- **Stream** individual readings to a computer or Bluetooth wireless printer as they are taken.
- **Print** to the optional battery powered Bluetooth wireless printer.

**On:** Turns Bluetooth functionality **On**. When selected, the  icon will appear on the display. To deactivate Bluetooth, select **Off**.

**Pairing:** The Gage and receiving device must be paired before stored or streamed readings can be transmitted. For pairing instructions, see [www.defelsko.com/bluetooth](http://www.defelsko.com/bluetooth)

**Info:** Lists information about your current Bluetooth connection, including the currently paired device and MAC address.

**Stream:** When checked, the Gage will stream readings to the paired Bluetooth Device as they are taken. Readings can be streamed as they are taken to the optional Bluetooth wireless printer (pg. 32) or third-party computer software.

## Bluetooth Wireless Printer

**PosiTector** Advanced models can output to the optional battery powered Bluetooth wireless printer one of two ways:



- Stream individual readings as they are taken.
- Print stored batch readings and summaries.

Begin by entering the **Connect > Bluetooth** menu. Turn Bluetooth **ON** and “Pair” the **PosiTector** to the printer. See: [www.defelsko.com/bluetooth](http://www.defelsko.com/bluetooth)

Streaming: In the **Connect > Bluetooth** menu, select the “**Stream**” tick box. All readings will now be simultaneously displayed on the LCD and sent to the printer.

Printing: In the **Memory** menu, select **Print**.

**WiFi** *(Advanced models only)*



Allows wireless communication with devices such as tablets, smart phones and computers connected to your local wireless network or portable mobile hot spot. See [www.defelsko.com/WiFi](http://www.defelsko.com/WiFi)

**On/Off** : Turns WiFi functionality **On**. When selected, the  icon will appear on the display. To deactivate WiFi, select **Off**.

**Access Point** : Connect your smart device/computer to a PosiTector Advanced body wirelessly without the need for a separate network. Wirelessly import readings into *PosiSoft 3.0 Desktop Software* (pg. 27) or access *PosiSoft Mobile* (pg. 28) in the field or whenever a WiFi network is not available or out-of-range.

To enable, select **Access Point** from the **Connect > WiFi** menu. The Access Point icon  will display in the upper left of the PosiTector display.

## Securing your Access Point

To ensure the PosiTector is only accessible to authorized devices, it is important that you enter a passphrase (password) for the Access Point. The default Passphrase is **password**.

In the **Connect > WiFi > Setup** menu, select **AP Passphrase**. Press  button to display on-screen keyboard. Enter a Passphrase for the Access Point. The Passphrase will be required for all devices connecting to the PosiTector's Access Point.

The PosiTector is now visible to all WiFi enabled devices. Simply connect your devices WiFi to the new PosiTector Access point. All PosiTectors are uniquely identified by their respective gage body serial numbers.

## AP Channel

Default Channel: 6

For most users the default channel will not have to be altered. If you are experiencing poor connection or are unable to connect, try another channel.

In the **Connect > WiFi > Setup** menu, select **AP Channel**. Press the **UP** center navigation button to highlight the channel. Use the (-) or (+) buttons to change the channel. Press the **DOWN** navigation button and select **OK**. Press the  button.

## Import readings into PosiSoft 3.0 Desktop Software (pg. 27)

From the PosiSoft 3.0 menu, select **Import > From Gage**. All connected gages will display their unique serial number. Measurement data will be displayed upon completion of the import.

The time it takes for import will depend on the number of Batches and measurements present within the gage. Imports generally take no longer than a few seconds.

Batches are not erased from the gages memory during import. They remain on the gage until they have been deleted by the user. For more information regarding PosiSoft 3.0:

[http://www.defelsko.com/posisoft/posisoft\\_software.htm](http://www.defelsko.com/posisoft/posisoft_software.htm)

## **Accessing your PosiTector PosiSoft Mobile** (pg. 28)

### ***For use on Apple iOS and Android devices:***

*PosiSoft Mobile Manager* apps exist for Apple iOS and Android users. Simply download the App from the Apple App Store or Google Play.

Once your smart device/computer has been connected to the PosiTector Access Point, open the *PosiSoft Mobile Manager* app. Select your PosiTector from the list to open PosiSoft Mobile.

### ***For use with all WiFi enabled devices:***

Any WiFi enable device connected to the PosiTector Access Point can view the instrument's built-in PosiSoft Mobile web interface. Using your device's web browser, enter the IP address of your PosiTector to access the features of PosiSoft Mobile.

In the **Connect > WiFi** menu, select **Information** to view the IP address associated with your PosiTector.

Enter the displayed IP address into your devices web browser exactly as it appears. Example: 192.168.0.1:8080

For more information regarding PosiSoft Mobile:

[http://www.defelsko.com/posisoft/posisoft\\_mobile.htm](http://www.defelsko.com/posisoft/posisoft_mobile.htm)

**Networks:** The Gage will allow the user to add a new network and will automatically check for available local networks. Available networks detected by the Gage are listed on the screen along with any networks that the Gage has previously been connected to that are not currently within connection range.

**Information:** Gage displays information about the local WiFi network connection including...

- SSID: the network's name
- State: displays if the Gage is connected to the network or not
- IP Address: the network's IP Address. Users can enter this number into a web-browser of any WiFi enabled device that is connected to the same network in order to view the Gage's synced batches through **PosiSoft Mobile** (See pg. 28).

**Setup:** Allows user to setup a WiFi connection

- IP Settings: enter the IP information as follows... IP Type (DHCP or Static), IP Address, Gateway, Netmask, DNS1, DNS2.
- Server Enable: enables a connection between the network and the Gage.
- Gage Name: enter a name for the Gage (up to 14 Characters).
- WiFi Reset: erases all WiFi settings.

## Updates

Determines if a software update is available for your Gage. If an update is available, a prompt will appear allowing the user to choose to perform the update at this time or not.

To perform an update the Gage must be connected to an internet connected PC with *PosiSoft Desktop Manager* (pg. 26), or **WiFi** network (pg. 32).

**NOTE:** Ensure that stored measurements are backed up to a PC or *PosiSoft.net*. The Gage may perform a **Hard Reset** (pg. 13) after completion of the update and ALL readings in memory would be erased.

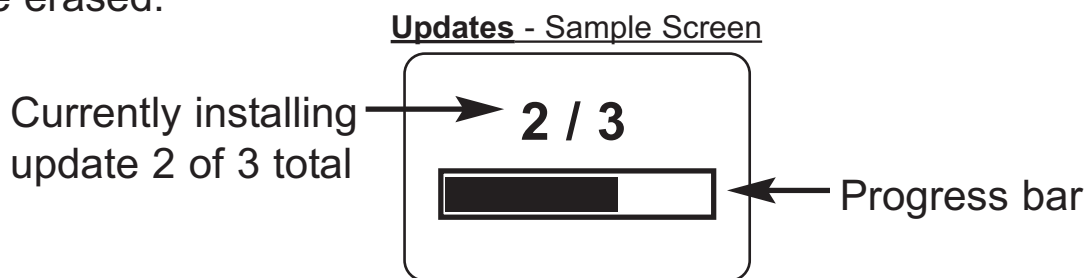

 **DO NOT** unplug the Gage during the update operation.

## Application Notes

### Measuring on pipes (*UTG C probes*)

When measuring the thickness of pipe walls, the proper placement of the transducer is important. On pipe diameters larger than 10cm (4 inches), it is recommended to place the probe parallel to the long axis of the pipe. For smaller diameter pipes, it is recommended that two measurements be taken, one with the probe perpendicular, and another with the probe parallel to the long axis of the pipe. The smaller of the two measurements should be recorded as the thickness for that area.

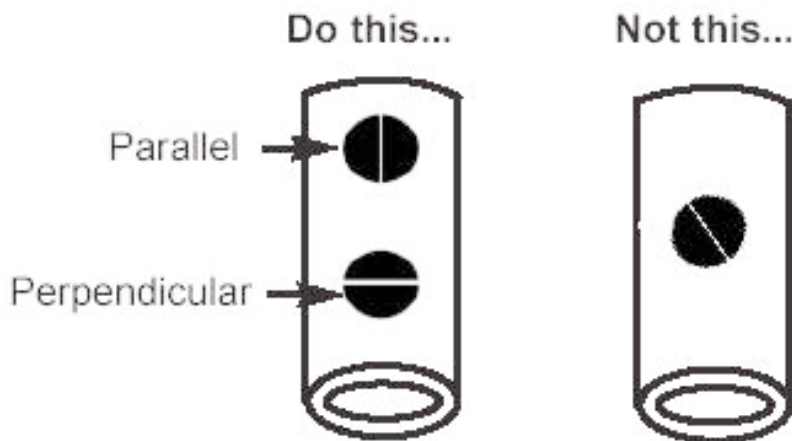

**Parallel** - Better when measuring pipes with a diameter greater than 10cm (4 inches).

**Perpendicular** - Typically better when measuring small diameter pipes.

### Measuring on rough surfaces

To optimize measurement results, the surface should first be cleaned of any foreign debris including rust and scale. Depending on the amount of contamination/ roughness, abrasion with a wire brush or grinding tool may be necessary.

On rough surfaces, the use of a generous amount of couplant minimizes the surface effects and serves to protect wear on the transducer, particularly when dragging across the surface is involved.

During scanning operations, the probe can become physically decoupled, that is physically separated, from the material, either due to the rough and/or scaly surface of the material or due to user operation. Avoid this by using the **Smart Couple™** feature (pg. 17).

### **Measuring on hot surfaces**

Measurements taken at higher temperatures (above 100° C / 212° F) require special consideration. Both material sound velocity and probe zero will change with temperature. For maximum accuracy at high temperatures, adjustment should be performed using a material of known thickness heated to the temperature where measurements are to be performed. The probe should remain on the surface **only** as long as it takes to get a measurement.

The surface temperature of the test piece should not exceed (150° C / 300° F).

### **Measuring laminated materials**

The density (and thus sound velocity) of laminated materials often varies considerably within a single piece or from piece to piece. For best accuracy, perform a calibration adjustment to a sample of known thickness. This sample should be as close as possible to the density characteristics of the part to be measured. Be aware that air gaps between laminates will likely cause strong reflections, resulting in the Gage measuring a lower thickness value than the actual total thickness.

### **Calibration**

Measurement accuracy is directly related to the accuracy and care taken when performing a gage calibration adjustment. Adjustments will likely be required whenever the test material or temperature changes. Periodic checks with samples of known thickness are recommended to verify that the Gage is operating properly.

### **Taper or Eccentricity**

If the measured surface and the back wall are not parallel to one another, measurement accuracy may be diminished due to a distorted echo.

### **Sound Scattering**

Some materials have conditions which can limit the accuracy and thickness range of the Gage. For example, individual crystallites in cast metals and dissimilar materials in composites can scatter the ultrasonic pulse. The return echo may be too weak for the Gage to effect a measurement.



## Troubleshooting

Some common reports received by our Service Department along with possible causes. Most conditions however can be cleared with a **Reset** (pg. 13).

### ***UTG C and UTG M probes***

#### **Gage fails to power down**

Ensure the probe is clean and free of couplant. The Gage will not turn off if coupled symbol  is displayed on LCD.

#### **Probe continues to measure after lifted from surface**

Wipe away any excess couplant on probe tip.

#### **Gage is coupled, but not measuring**

See *Surface Conditions*, pg. 7.

#### **Gage readings appear to be double the expected thickness**

This sometimes occurs near the minimum measuring range of the instrument. The first return echo is unmeasurable, so the Gage measures the second return echo. The resultant calculation is double the actual thickness.

#### **Measurement jumps as probe is lifted from surface**

Occasionally, excess couplant will remain on the probe when the probe is lifted from the surface. This may cause the ***PosiTector UTG*** to display a final measurement value different from those observed when the probe was on the surface. Discard this value and repeat the measurement.

## ***UTG M multiple echo (ME) probes only***

**Gage displays --- (dashed lines) when measuring on an smooth uncoated surface in multiple echo mode**

See *UTG M probes* note on pg. 5

### **Gage is coupled, but not measuring**

On smooth, uncoated metal surfaces the Gage (in multiple echo (ME) mode) may occasionally be unable to give a measurement result even when the "coupled" symbol appears. Use additional couplant and lighter pressure on the probe when measuring. Switching the Gage to SE mode (pg. 16) will also help produce a steel-only thickness measurement. Alternatively, laying a plastic shim on the surface with couplant applied to both sides to simulate a painted surface will help produce a steel-only thickness measurement in ME mode.

### **When measuring non-parallel surfaces, ME mode does not display a reading**

Measurement accuracy may be diminished when ME mode is used to measure a part that has non-parallel surface and back walls. A distorted echo or no echo at all may result. Switch to SE mode (pg. 16) and retry.

### **Thickness values are repeatable, but seem incorrect**

1. When measuring thick, hard coatings on thin metal, ME and SE modes may both give improper results. This unusual condition results in many gages interpreting the thick coating as the metal and the thin metal as a coating on the backside. The Gage therefore displays the thickness of the coating using the velocity calibration for the metal. This application may not be measurable.

Or

2. The **Cal Settings** property may be incorrect. For best accuracy the Gage must be set to the correct sound velocity for that material (see pg.11).

Or

3. Too much loose rust or scale may be present on the surface. Scrape away loose material with a wire brush or scaper and apply sufficient couplant. In extreme cases, rotary sanders or grinding

wheels may be necessary using care not to gouge the surface.

Or

4. There may be a coating on both sides of the metal. Switch to SE mode for best results.

### **ME (multiple echo) and SE (single echo) results are not the same**

When measuring a COATED piece of metal, ME and SE modes will likely produce different thickness values as expected. The ME value will be thinner since it represents the thickness of only the metal (ignores the coating).

Measurements of an UNCOATED piece of metal, however, should be the same (within tolerance) except in the following circumstances...

*Surface Roughness, scale, etc.*

ME mode may produce thinner measurement results because it may ignore the surface roughness in much the same way it ignores coatings.

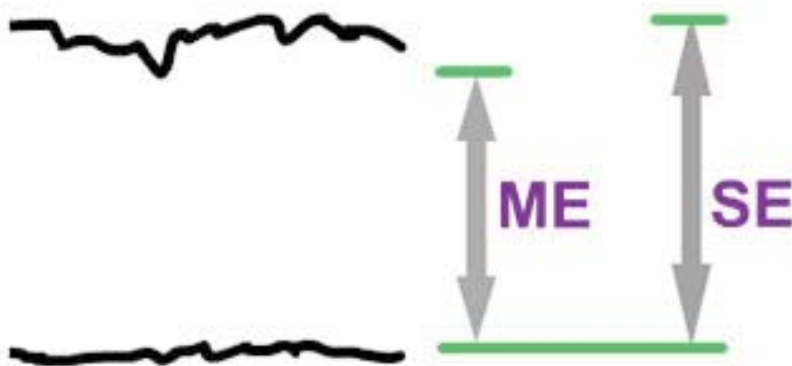

### *Flaws, voids or pits*

A void or flaw inside a metal object is better detected in SE mode where the Gage will measure the distance from the surface down to the flaw. Scan-mode will help locate the flaw. In ME mode the Gage may not “see” the flaw and will display a thicker, total thickness value.



### *Measuring the depth of a rod*

ME mode may produce accurate results in situations where SE mode may not be able to measure at all.

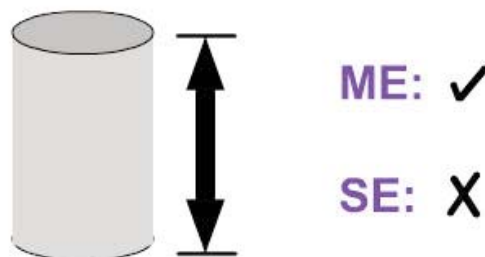

### *Probe pressure*

Applying too much hand pressure on the probe while measuring may squeeze out too much couplant and make it difficult for ME mode to effect a measurement.



### *Temperature*

Probe temperature: ME values are not affected by temperature changes within the probe. But the Gage should be zeroed (pg. 10) for best accuracy when operated in SE mode.

Metal temperature: Sound waves travel faster when the material is heated. Preprogrammed sound velocities within the PosiTector UTG are valid for normal temperatures in the vicinity of 15°C and must be adjusted for extreme temperatures. For best results in either mode, the Gage should be adjusted to the known thickness of the material at a temperature similar to the part being measured.

## Power Supply / Battery Indicator

**Power Source:** 3 AAA alkaline, Lithium or optional Nickel-metal hydride (NiMH) rechargeable batteries. For best battery indicator results, ensure the appropriate **Battery Type** is selected in the **Setup > Battery Type** menu (pg. 18).

The battery indicator  displays a full bar with fresh alkaline or fully charged batteries installed. As the batteries weaken, the bar will be reduced. When the battery symbol is low  the Gage can still be used, but the batteries should be changed or recharged at the earliest opportunity. The Gage will turn off automatically when batteries are very low, preceded by a Low Battery Warning on the display.

 To retain all user settings and stored memory readings, only replace the batteries after the Gage has powered-down.

Battery performance decreases at low temperatures.

## Additional Accessories

### Rechargeable Battery Pack - 4 AAA eneloop batteries

The **PosiTector** can operate on rechargeable batteries and DeFelsko recommends the use of *eneloop* (NiMH) rechargeables. *eneloop* batteries combine the advantages of regular rechargeable batteries and disposable (Alkaline) batteries. They discharge very slowly and can be stored for long periods without having self discharge concerns. Eneloop batteries come pre-charged and ready to use immediately. See: [www.eneloop.info](http://www.eneloop.info)

### AC Power Cable Kit

An optional AC Power Cable Kit is available for continuous operation or battery charging through the **PosiTector's** built-in USB port (as shown on page 26). This kit supplies several alternate power solutions for your battery-operated **PosiTector**. They allow the gage to operate continuously without the need for batteries.

Use the USB cable alone to connect a **PosiTector** to your PC's built-in USB port that acts as a continuous power source. Or connect the cable to the included power adaptor which plugs into any AC wall electrical outlet, 110 or 220V.

A selection of electrical plugs is included which are capable of dealing with most country's outlets. The USB cable provided can also be used for **Accessing Stored Measurement Data** (pg. 23).

## **USB Cable**

A USB Cable is provided with every **PosiTector**. Replacement USB cables are available.

## **Couplant**

One 4 oz. bottle of Ultrasonic Gel (couplant) is provided with every **PosiTector UTG** probe. Additional 4 oz. bottles are available and sold in a cases of 12.

## **Certified Step Block**

Ideal for checking calibration and operation of ultrasonic thickness gages and are an important component in fulfilling both ISO and in-house quality control requirements. Supplied with a Certificate of Calibration traceable to NIST. Available in metric or imperial units.

## **Bluetooth Printer**

This lightweight wireless printer receives data from all **PosiTector** gages via Bluetooth wireless technology. It is battery-operated and prints readings and statistical summaries.

## **Nylon Case**

Convenient soft shell nylon case for carrying a **PosiTector**. Case has compartments for Certificates of Calibration, instruction manuals and other accessories.

## **Protective Lens Shield**

One lens shield is included with every **PosiTector** instrument. Additional package of five (5) thin plastic lens shields are available and ideal for protecting the **PosiTector** display from paint and overspray.

# Technical Data

Probe Details & Specifications	Corrosion	Multiple Echo
Probe	UTG C	UTG M
Probe Type	5 MHz Dual Element	5 MHz Contact
Thru-Paint Capability (Multiple Echo)	no	yes
Measurement Range* - Single Echo	0.040" to 5.000" 1.00 to 125.00 mm	0.100" to 5.000" 2.50 to 125.00 mm
Measurement Range* - Multiple Echo	NA	0.100" to 2.500" 2.50 to 60.00 mm
Resolution	0.001" 0.01 mm	0.001" 0.01 mm
Accuracy	±0.001" ±0.03 mm	±0.001" ±0.03 mm

\* Measurement range is for carbon steel and depends upon surface condition, temperature and material.

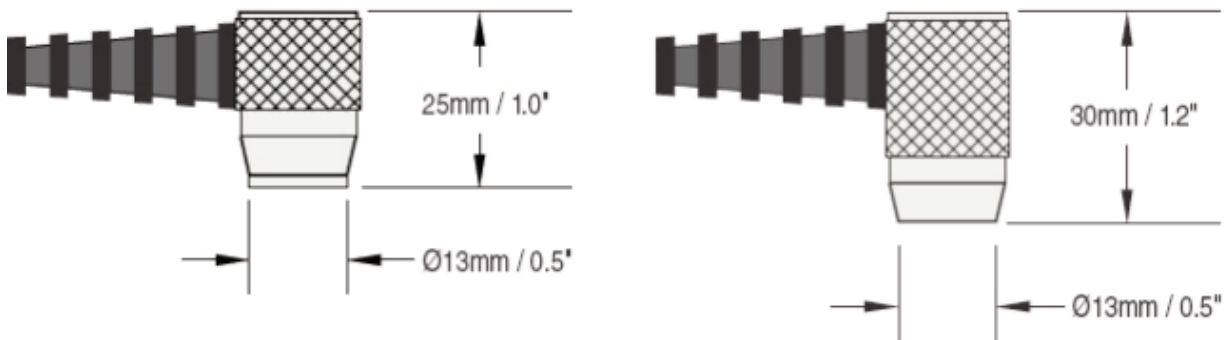

## Operating Range:

Gage: 0 to 50° C (+32° to +120° F)

Probe: -20° to 55° C (-4° to +131° F) continuous

Material Surface Temp: -40° to +150° C (-40° to +300° F)

**Size:** 146 x 61 x 28 mm (5.75" x 2.4" x 1.1")

**Weight:** 140 g (4.9 oz.) without batteries

**Conforms to:** ASTM E797

This device complies with part 15 of the FCC Rules. Operation is subject to the following two conditions: (1) This device may not cause harmful interference, and (2) this device must accept any interference received, including interference that may cause undesired operation.

## Returning for Service

Before returning the instrument for service...

1. Install new or newly recharged batteries in the proper alignment as shown within battery compartment.
2. Examine the probe tip for dirt or damage.
3. Perform a **Hard Reset** (pg. 13) and a **Zero** (pg. 10).

### **IMPORTANT:**

If you must return the Gage for service, please fill out and include the Service Form located at [www.defelsko.com/support](http://www.defelsko.com/support) with the Gage. Be sure to also include the probe, your company name, company contact, telephone number and fax number or email address.

## Limited Warranty, Sole Remedy and Limited Liability

DeFelsko's sole warranty, remedy, and liability are the express limited warranty, remedy, and limited liability that are set forth on its website: [www.defelsko.com/terms](http://www.defelsko.com/terms)



*The Measure of Quality*

**[www.defelsko.com](http://www.defelsko.com)**

© DeFelsko Corporation USA 2014  
All Rights Reserved

This manual is copyrighted with all rights reserved and may not be reproduced or transmitted, in whole or part, by any means, without written permission from DeFelsko Corporation.

DeFelsko and PosiTector are trademarks of DeFelsko Corporation registered in the U.S. and in other countries. Other brand or product names are trademarks or registered trademarks of their respective holders.

Every effort has been made to ensure that the information in this manual is accurate. DeFelsko is not responsible for printing or clerical errors.