



because it works

Operating Manual

WIWA INJECTION EQUIPMENT



Type:

- Inject HD 1
- Inject HD 2

Factory No.



Contents

1 Preface	4
2 Safety	4
2.1 Description of symbols	4
2.2 Dangers arising from the equipment	5
2.3 Application of the machine	5
2.4 Machine surroundings	5
2.4.1 Rebuilds and changes	5
2.4.2 Danger caused by attachments and spare parts	6
2.4.3 Emissions	6
2.5 Sources of danger	6
2.6 Operating staff	7
2.7 Installation site and Transporting and additional equipment	8
2.8 Behavior in case of emergency	9
2.9 Protective equipment	10
2.10 Handling of the machine and auxiliary materials	11
3 Machine description	12
4 Start up	13
4.1 Set-up and Assembly	13
4.2 Initial cleaning	14
4.3 Checking pressure	15
5 Operation	17
5.1 Equipment preparation	17
5.2 Injecting	19
5.3 Pauses in work and changing injection materials	20
5.3.1 Pauses in work	20
5.3.2 Change of material	20
6 Shutting down	21
7 Maintenance / Repair	23
7.1 Checks	23
7.2 Maintenance plan	23
8 Disturbances during operation and troubleshooting	24
9 Appendix	26
9.1 Technical specifications	26
9.2 Machinery materials	26
9.3 Instruction Certificate	27
9.4 Machine card	27

1 Preface

This User's Handbook must always be available to operating staff!

The operating authority of the equipment must ensure that a User's Handbook is available to the operator in a language which he understands.

Dear customer!

Thank you for your decision to purchase **WIWA**® equipment.

In the user's handbook, you can find all information required for the proper handling of your **WIWA**® Injection Pump. However, for safe operation there are further essential details which you should adhere to:

Please read and observe the guidelines valid for your country.

In Germany, the „**Richtlinien für Flüssigkeitsstrahler**“ (Guidelines for fluid sprayers) published by: Hauptverband der Gewerblichen Berufsgenossenschaften (Industrial Employer's Liability Insurance Association), are valid.

Additionally, the manufacturer's instructions and all processing guidelines covering injection materials are to be followed closely.

No method of operation should be exercised which impairs the safety of **WIWA**® products and the operating personnel.

We wish you much success and excellent working results when applying your **WIWA**® Injection Pump.

WIWA Wilhelm Wagner GmbH & Co. KG

Copyright
© 2011 WIWA

Copyright ownership for this user manual remains with
WIWA Wilhelm Wagner GmbH & Co. KG
Gewerbestr. 1-3 • 35633 Lahnau • Germany
Phone: +49 6441 609-0 • Fax: +49 6441 609-50
E-Mail: info@wiwa.de • Homepage: www.wiwa.de

This operating manual is solely intended for personnel involved in preparation, operation and servicing.

It is prohibited to pass on this operating manual for reproduction, utilisation or communication of its contents, unless this has been explicitly permitted. Infringements incur an obligation to pay damage compensation. All rights reserved in the event of registration of the patented design, industrial design or registered design.

This operating manual only applies in conjunction with the machine card that was given to you with the user manual for your equipment. Please check that the type plate data is identical with the information on the machine card. Please notify us immediately if there are discrepancies, if the user manual has been incorrectly compiled or if the type plate is missing.

2 Safety

2.1 Description of symbols

The signs and symbols used in this User's Handbook have the following meaning:



NOTE

This marks a section of text which is especially relevant to safety. Special attention should be paid to this section and the contents strictly observed.



SMOKING PROHIBITED

This marks a situation in which a fire hazard arises through the use of flammable or explodable solid, fluid or gaseous materials.



WARNING

This marks a situation which could be dangerous. If not observed, death or very serious injuries could result.



DANGER OF EXPLOSION

This marks a situation, where there is danger of explosion. Observation of this information is absolutely essential.



ELECTRICAL VOLTAGE

This marks a situation, where there is a danger of explosion through an electrostatic charge. Observation of this information is absolutely essential.



USE EAR PLUGS

For health reasons, it is very important to pay attention to this warning.



USE BREATHING PROTECTION

For health reasons, it is very important to pay attention to this warning.



HEALTH DANGER

This marks materials which are hazardous to your health. Observation of this information is absolutely essential.



FIRST AID

In case of injuries or accidents, these instructions should be absolutely adhered to.

2.2 Dangers arising from the equipment

This machine was designed and built in accordance with all safety guidelines. It corresponds with the present standards of technical regulations and current rules for accident prevention.

It left the factory in perfect condition and ensures a high level of safety. However, the following dangers exist if operated incorrectly or used inappropriately:

- to life and limb of operator or third persons or third persons
- for the machine and other property belonging to owner of machine
- for the efficient working of the machine

All personnel involved in the starting, operation and maintenance of the machine must read the following notes carefully and observe them. It is a matter of their safety! We recommend that the machine operation management have this confirmed in writing.

Additionally, please pay attention to the following: We recommend adding a copy of all guidelines and accident prevention regulations into the user's manual.

2.3 Application of the machine

This **WIWA**® injection unit is designed according to the requirements found in German ZTV-Riss guidelines for pneumatically driven, single component, high-pressure equipment.

It is recommended for use with low-viscosity injection materials made from epoxy or polyurethane and for processing sealant gels.

This equipment is easy to transport and ideal for use on scaffoldings and in narrow shafts. The stroke rate of the motor informs the operator how close the injection work is to completion. When the motor stops, the bore hole being injected is full. To drive the pump, a portable 220V compressor with an air output of approx. 200/Nltr. should be sufficient.

Other usage is not in line with regulations. Before **WIWA**® equipment is used for other purposes or with other materials, and, therefore, not according to the regulations, permission should be obtained from the manufacturer, as the guarantee is otherwise invalid. The observation of technical documentation and the compliance with specified operational, maintenance and starting guidelines are mandatory in accordance with the valid regulations.

2.4 Machine surroundings

2.4.1 Rebuilds and changes

For safety reasons, it is not allowed to carry out rebuilds or changes without authorization.

Protective equipment may not be dismantled, changed or neglected.

If using components which are not produced or delivered by **WIWA**®, warranty coverage is negated as well as liability.

The machine may only be operated within the prescribed limits and machine parameters.

2.4.2 Danger caused by attachments and spare parts

If you use original attachments and original spare parts from **WIWA**, the compatibility with our equipment is guaranteed. It is, however, essential that the safety regulations of the attachments and spare parts are observed. You can find these safety regulations in the User's Handbook located with the spare parts lists.

If you use attachments and spare parts from another source, **WIWA** cannot guarantee the safety of the entire system. In this case, our guarantee does not cover any damage or injury caused by such attachments and spare parts.

2.4.3 Emissions

It is possible for solvent vapours to occur, depending on the materials used. Therefore, please ensure the workplace is sufficiently ventilated in order to avoid damage to health and property. Always observe the processing information given by the material manufacturer.

The sound pressure level of the equipment is below 85 db(A).

Nevertheless, appropriate means of noise protection should be made available to the operating staff.

The operator is responsible for compliance with the rules covering the prevention of accidents due to „noise“ (VGB 121). Therefore, pay special attention to the environmental conditions at the site, e. g. noise can be increased if the machine is installed in or on hollow bodies.

Exact details regarding noise emission are mentioned in the Chapter 9.1 Technical specification.

2.5 Sources of danger



Remember that **WIWA** Injection Pumps work under extreme pressures and that they can cause life-endangering injuries if used inappropriately.



Pay attention to the following notes:

- Material hoses must conform to the prescribed maximum working pressure, allowing for a suitable safety factor. Material hoses are never to be „patched“!
- Never point the injection lance towards yourself, other people or other living creatures.
- Never hold your finger or hand in front of the injection lance and never reach into the injection stream.
- Never try to seal leaks on joints and high pressure hoses with your hand or by binding the spot. Should a leak occur, the whole system (injection lance, hose, pressure filter, pump, etc.) is to be depressurized immediately. Defective parts are to be replaced.
- Shut off the injection lance at every pause in working, regardless how short.

- The entire system is to be depressurized before maintenance and cleaning work is carried out. The compressed air tap lock must be closed.
- Never spray solvents or materials containing solvents into a narrow-necked can or barrels with bung hole. **DANGER OF EXPLOSION!**
Always use an open container. When using metal containers, always ensure that the injection lance maintains contact with the container wall to avoid the build up of electrostatic charges.
- If the material being used clogs or clumps within the pump, residual pressure may still exist despite depressurization efforts. This must be kept in mind when carrying out repairs! Special care must be taken when dismantling the material hoses and injection lance to ensure that no accidents occur due to escaping residual pressure.
We recommend covering the material hose fittings with a cloth during unscrewing in order to capture any fluid which might escape.
- Never remove the sealed safety valve installed by **WIWA**® and never adjust its setting.
- Should the safety valve need replacing, please see the machine card for its order number (chapter 9.4).
- Please ensure that new safety valves are set and sealed to the maximum permitted air inlet pressure for the **WIWA**® Injection Pumps (see nameplate/ machine card).
- In closed or pressurised systems where aluminium or galvanised parts come into contact with the solvent, dangerous chemical reactions can occur if 1.1.1-Trichlorethylene, Methylene Chloride or other solvents containing halogenated chlorinated hydrocarbons (CFCs) are used. If you wish to work with the above solvents or with lacquers and paints which contain them, we recommend you contact either **WIWA**® customer services or **WIWA**® directly.
- The maximum operating pressures given by us are to be adhered to in principle for all **WIWA**® parts (i.e. pump, hoses, injection gun / lance, safety valve). By differing allowable operating pressures, the lowest value is always the maximum allowable operating pressure for the entire system.
Example:
Pump up to 420 ba
Material hose up to 600 bar
Injection Lance up to 350 bar
The maximum allowable operating pressure for this system would be 350 bar.
- Smoking is prohibited in the entire area of operation!

2.6 Operating staff

Authorised Operators

People under the age of 16 should not operate this equipment. The management in charge of the operation of the machine must make the User's Handbook available to the operator and must make sure that he has read and understood it. Only then may the system be put into operation.

We recommend the manager has this confirmed in writing. The operator of the machine is obliged to report to the manager any changes in the machine which might affect its safety, as he must ensure that the machine is functional.

The responsibilities for the different activities on the system must be laid down clearly and adhered to. No unclear responsibilities may remain as this could endanger the safety of the users.

The operator must make sure that only authorised persons work on the machine. He is responsible to third parties in the working vicinity of the system.

The operator of the equipment is obliged to repeat instructions about dangers and safety measures at regular intervals (at least once a year, for operators under the age of 21 twice a year).

Personal protective equipment

We call to your attention that the valid guidelines and requirements in accordance with work surroundings (mining, closed areas etc.) must be absolutely adhered to.



- Please, wear the prescribed protective clothing at all times, as solvent vapours and solvent splashes cannot be completely avoided.
- The sound pressure level of the equipment is below 85 db(A). Nevertheless, appropriate noise protection means should be made available to the operating staff.
- Although solvent fumes are minimized when the injection pumps is handled properly, it is still recommended that the operator wear breathing protection.
- Never use solvent or other materials which present a health hazard for cleaning skin. Only suitable skin protective, skin cleansing and skin care materials may be used.

2.7 Installation site and Transporting and additional equipment

Safety measures at installation site

- The system must have a fixed position and sufficient space to ensure safe operating. Access to the safety devices must not be blocked.
- Keep the working area, especially all gangways and standing areas, clean. Remove spilled paint or solvent immediately.
- Ensure there is sufficient ventilation at the workplace to prevent damage to health and property. Observe the manufacturer's processing instructions at all times.
- Despite the fact that no legal regulations exist covering the low-fog airless spraying method, dangerous solvent fumes and particles of paint should be removed of per vacuum.
- Protect any neighboring objects against damage caused by possible overspray.
- Comply strictly with the current rules for accident prevention.

Transporting and additional equipment

- Cut off the air supply to the pump, even when transporting for short distances.
- Before transportation, empty the machine.
- Stay alert when loading the pump, whether a hoist is being used or not!
- Observe the max. load capacity of machines used for lifting.
- Never stand under suspended loads or in the lifting area. This is extremely dangerous!
- Only use suitable transportation vehicles with sufficient load capacity.
- Ensure the pump is properly secured to the vehicle transporting it to avoid slipping or tipping.



Picture 2.1

- Parts or equipment dismantled for transportation purposes must be properly remounted by a trained technician before start-up. To enable safe lifting, a grip is located on the injection pump's air motor, (picture 2.1).

➤

2.8 Behavior in case of emergency



Leaks

If leaks occur in the system:

- it must be shut down immediately and the entire system depressurized:
- Cut off the compressed air supply with the air tap lock.



Injury

- Should an injury occur through contact with liquid spray, we recommend a doctor be called immediately.
- Inform the doctor of the material sprayed (e.g. paint) and the solvent (thinner). Have the product data sheet at hand (address and telephone number of supplier or manufacturer, name of material and material number).
- Memorize where you can call for aid.
- Memorize the local emergency phone numbers.
- Become familiar with the first-aid measures.

Fires

- Read the instructions for fire alarm and escape routes put up in your factory.
- Do not apply any other extinguishing agents than those which are prescribed by the manufacturer of the materials.

2.9 Protective equipment

All equipment is delivered with the following safety devices:

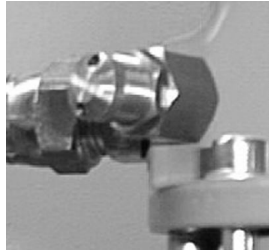

Picture 2.2

- **Safety valve** (picture 2.2)
The safety valve prevents the maximum admissible entry air pressure being exceeded. In the event that the fixed maximum entry air pressure setting is surpassed, the safety valve blows open.

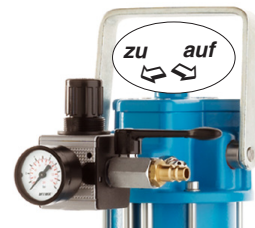

Picture 2.3

- **Air lock** (picture 2.3)
The tap for locking compressed air makes it possible to switch off the machine immediately.

All protection devices must be checked!

- Before each commissioning of the machine!
- Before beginning work on or with the machine!
- After all aligning work!
- After cleaning and servicing!
- After maintenance and repair!

Check list for inspecting the protection features

- **when the unit is in a depressurized state**
- Inspect the safety valve leading or seal for damage.
- Inspect the safety valve for visible damage.
- Inspect the compressed air tap lock for perfect functioning.

If a protective device is not fully operative, or another defect is detected on the machine, cut off the compressed air supply to the machine immediately and open the injection lance ball valve. (Hold the injection lance in an empty container while doing this.)

The machine may only be restarted if perfect operation is restored.

2.10 Handling of the machine and auxiliary materials

Alignment, servicing, maintenance and repair of the machine

- Alignment when changing production, as well as servicing and cleaning, may be carried out by trained operating personnel only.
- Maintenance and repair may be carried out by trained, qualified personnel only.
- Before starting work, the compressed air supply of the pump must be shut-off.
- Make sure that the pump is absolutely free from pressure.
- In any case, the function of all protective devices, as well as perfect function of the machine, must be checked after completion of the work.

Handling of auxiliary materials

- When working with injection materials and their related solvents (or other chemical substances), it is mandatory to observe the manufacturer's safety and dosage instructions as well as industry guidelines.
- Residual injection material, solvent and other chemical substances must either be recycled or disposed of according to legal standards.
- The local official laws for the protection of waste water must be observed.

3 Machine description

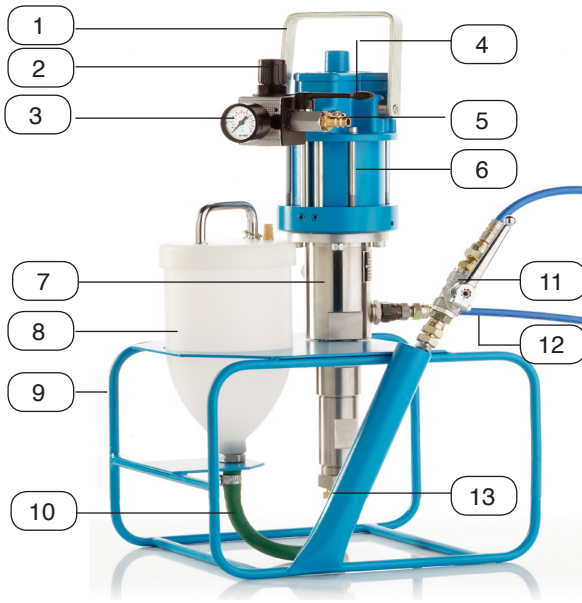

Picture 3.1 HD 1 (Injection lance with ball valve)

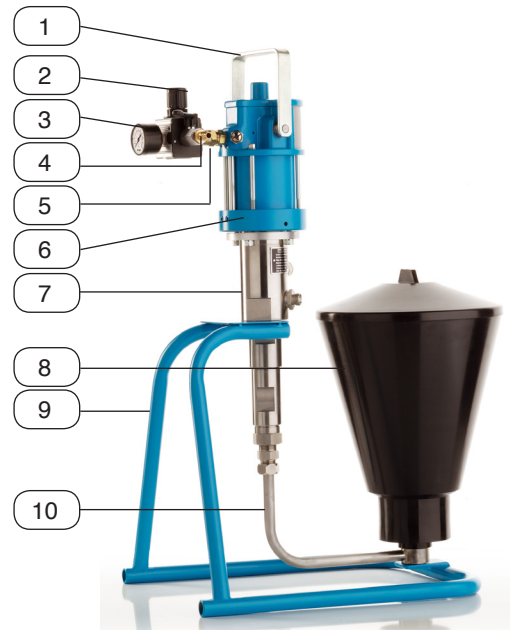

Picture 3.2 HD 2



Picture 3.3 Injection lance with trigger lever

Pos.	Description
1	Lifting handle
2	Air pressure regulator
3	Pressure gauge
4	Air tap lock
5	Inbound air connection
6	Air motor
7	Material pump

Pos.	Description
8	Material feed container
9	Frame
10	Suction hose
11	Injection lance
12	Fluid hose
13	Holding pipe for the injection lance

4 Start up

4.1 Set-up and Assembly

Task

You wish to erect the machine at the site and prepare it for operation.

Prerequisite

- The material to be worked with is prepared.
- All materials to be sprayed should be marked with information on viscosity, processing temperatures, mixing proportions etc. If this is not the case, please, acquire this data from the relevant manufacturer.
- The material to be sprayed must be slowly but thoroughly stirred before beginning to work.
- When dealing with two-component materials, the potlife life must be observed. The machine must be flushed and completely cleaned with the specified cleaning agent within the potlife life as given by the manufacturer. Please, observe that the hardening time shortens at higher temperatures. It is recommendable to allow the solvent to circulate for a while. It must be made certain that no particles of paint remain in either the pump or the filter.

Procedure

1. The machine is to be set up securely on a level and solid surface. All operating elements must be easily accessible. In order that the necessary volume of air is guaranteed, the compressor capacity must comply with the amount of air needed by the machine and the diameter of the air supply hoses must correspond to the joints.
2. Several components of the machine were dismantled and packed in a separate carton for shipping (i.e. fluid hose, injection lance, air pressure regulator). Assemble these components as described in chapter 3.
3. Inspect all turnable parts, nuts, screws and hose connections and pull on them tightly to ensure that no material could leak out of these fittings which could lead to injuries.
4. Please, check the permissible maximum air pressure for the material hose and injection lance. It must be greater than or equal to the maximum operational pressure for the system, which is shown on the nameplate on the high pressure pump or on the machine card (chapter 9.4).
5. Compare the maximum operating pressure of the safety valve with the information on the machine card (chapter 9.4) or the nameplate. This information must correspond.

- The pump may now be filled with release agent (see chapter 7.2, Maintenance Plan). We recommend using **WIWA®** release agent, order no.: 0163333.

Result

The machine is now ready for operation.

Continue with the first cleaning (chapter 4.2).

4.2 Initial cleaning

Task

This machine was factory tested after assembly for perfect functioning with a test-medium. The entire system should be flushed with cleaning solvent before spray operation begins so that the material to be sprayed is not affected by the test-medium.

Prerequisite

You will need:

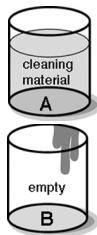

1 open container with approx. 5 liters of solvent, hereafter called container „A“.

1 empty, open container for the mixture of cleaning material and test-medium, hereafter called container „B“.

Do not use narrow-necked cans or barrels with bung hole.

Please, check whether the material hoses comply with the maximum working pressure and the prescribed safety factor. They should not have any leaks, kinks, signs of wear or bulges. The hose fittings must be securely attached and also comply with maximum pressure.

Please wear protective clothing at all times, as solvent vapours and splashes of solvent cannot be avoided completely.

Procedure

- The air tap lock must be closed.
- Connect the fluid hose to the injection lance.
- Connect the fluid hose (with the injection lance) to the fluid output on the material pump.
- Turn the air regulator control screw to the left until it turns freely.
- Connect the inbound air connection to the compressed air line.

6. Fill solvent (container „A“) into the unit's feed container.
7. Open the air tap lock.
8. Adjust the air regulator to a maximum of 2 bar by slowly turning the control screw to the right.
9. Hold the injection lance into the open container „B“ and spray for at least 10 seconds against the inside wall. When using a metal container, ensure that contact is maintained between the injection lance and the container wall (due to possible electrostatic charging).



We recommend a cleaning period of approx. one minute for a good cleaning result. In order to avoid the danger of explosion caused by the heating of cleaning material, it should not be pumped for longer periods of time (a maximum of 5 minutes).

Result

The machine is now completely flushed. Continue with the pressure check (found in chapter 4.3)

4.3 Checking pressure

Task

You want to inspect the seal on all system components.

Procedure

1. Close the injection lance.
2. Open the air tap lock and set the maximum allowable inlet pressure by turning the control screw on the air pressure regulator to the right .

Observe the maximum allowable operational pressure for all accessory components. By differing allowable operating pressures, the lowest value is always the maximum allowable operating pressure for the entire system (see example in chapter 2.5).

If the pressure is increased by approx 10% for a short length of time, the safety valve must blow off.

3. Now check that all parts of the system are tight (fluid hose, injection lance and connections).
4. Now, adjust back the air inlet pressure by turning the control screw of the air regulator to the left to approx. 1-2 bar.

5. Empty the unit's feed container. (Return remaining solvent to container „A“.)
6. Slowly open the injection lance and completely pump out any remaining solvent still in the pump. Ensure the injection lance remains in contact with the container wall.
7. Adjust back the air regulator by turning the control screw to the left until it moves freely.
8. Close the air tap lock.
9. Close the injection lance.

Result

The start-up procedures are finished. The pump is ready for use.

5 Operation

5.1 Equipment preparation

Task

You want to prepare the pump for injecting.

Prerequisite

You will need:



1 open container with approx. 5 liters of flushing agent (use the solvent which corresponds to the injection material and is recommended by the manufacturer), hereafter called container „A“.



1 empty, open container for the soiled cleaning material/material mixture, hereafter called container „B“



1 material container, hereafter called container „C“.

Do not use narrow-necked cans or barrels with bung holes.

Procedure

1. The air tap lock must be closed.
2. Adjust back the air regulator by turning the control screw to the left until it moves freely.
3. Connect to main air supply line.
4. Fill solvent from container „A“ into the pump's feed container.
5. Open air lock tap.
6. Open the injection lance while holding it into container „B“.
7. Adjust air regulator to 1-2 bar by turning the control screw to the right.
8. Hold the injection lance in such a way that the emerging solvent is sprayed sideways onto the inside wall of the open container „B“. When using metal containers, ensure that contact is maintained between the injection lance and the wall of the container to avoid electrostatic charging. As soon as clean solvent is released, the flushing process can be ended.



After long periods without use, you should carry out the following in order to test the tightness of the seals and joints in the equipment, but only with the injection lance ball valve closed:

9. Increase the pressure on the compressed air regulator to the given maximum air inlet pressure.
10. Inspect the joints for tightness on the parts which carry material.
11. Turn the air regulator slowly back to 1-2 bar by turning the control screw to the left.
12. Return any remaining solvent in the unit's feed container to container „A“ and pump out any remaining solvent in the system.
13. Turn the air regulator back by turning the control screw to the left until it moves freely.
14. Close the air tap lock.
15. Close the injection lance.
16. Fill injection material into the material container „C“.
17. Open the air tap lock and adjust air regulator to 1-2 bar.
18. Open the injection lance. Pump any solvent remaining in the fluid hoses and injection lance into the open container „B“ until pure injection material exits the lance. Ensure to maintain contact between the lance and container wall.
19. Close the injection lance.
20. Clean the injection lance coupling with solvent and a brush.
21. Regulate working pressure with the air regulator.

Result

The pump's preparation is completed.

You may now proceed with injecting.

5.2 Injecting

Job

You want to begin injecting.

Prerequisite

- You have prepared the unit according to chapters 4 and 5.
- Appropriate packers are available for the injection lance.

Procedure

1. Set the required packers into the wall which is to be injected.
2. Connect the injection lance nipple to a packer.
3. Set the required injection pressure using the air pressure regulator.



The injection pressure is calculated as follows:

The pressure set with the injection pump's regulating screw (visible on the pressure gauge) is multiplied by pressure ratio.

Example:

Pressure setting (pressure gauge reading) 4 bar

pressure ratio (Multiplier) 33

=> 4 bar x 33 = 132 bar

The material is injected at 132 bar.

4. Open the injection lance ball valve.

The injection material is now pumped into the foreseen location.



Fill the injection hole with as little pressure as possible to ensure the maximum safety to operating personnel and the masonry structure. When the hole is filled (pressure equalization), the pump will stop automatically.

Now, raise the injection pressure to the material manufacturer's recommendation. Once pressure equalization is reached again, the pump will stop automatically and the area to be injection is filled completely.

5. Adjust back the air regulator by turning the control screw to the left.
6. Close the injection lance.
7. Disconnect the injection lance nipple from the packer.

Result

The material has been injected successfully. We recommend to flush the pump between jobs, depending on the material and amount to be processed. Be certain to follow the instruction in chapter 5.3 „Pauses in work and changing materials“ closely to avoid damage to the unit.

5.3 Pauses in work and changing injection materials

5.3.1 Pauses in work

1. Close the injection gun if you make a pause of more than a couple of minutes while injecting.
2. Fill any remaining injection material in the feed container back into container „C“, as long as it is not mixed two component material.
3. Fill the pump's feed container with solvent (container „A“).
4. Open the air tap lock.
5. Turn the air regulator slowly to max. 1-2 bar by turning the control screw to the right.
6. Hold the injection lance in such a way that the soiled injection material is sprayed sideways onto the inside wall of the open container „B“.
7. Close the injection lance as soon as clean solvent emerges.



Closely observe the potlife stated by the manufacturer for the injection material being used.

If the pause in work is longer than the potlife allows, completely flush the system according to the instructions found in chapter 6.

5.3.2 Change of material

1. Complete the shutting down procedures described in chapter 6.
2. Complete the start-up procedures described in chapter 4.

6 Shutting down

Task

Once the job is completed, the pump is to be cleaned and shut down.

Prerequisite

You will need:



1 open container with approx. 5 liters of flushing agent (use the solvent which corresponds to the injection material and is recommended by the manufacturer), hereafter called container „A“.

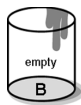

1 empty, open container for the soiled cleaning material/material mixture, hereafter called container „B“.

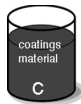

1 material container, hereafter called container „C“.



Do not use narrow-necked cans or barrels with bung holes.

Procedure

1. Close the air tap lock.
2. Turn back the air regulator by turning the the control screw to the left until it moves freely. The pressure gauge must show 0 bar.
3. Close the injection lance.
4. Empty the unit's feed container. Fill remaining material back into container „C“, as long as it is not mixed two component material.
5. Fill the unit's feed container with solvent from container „A“.
6. Open the air tap lock and set the pressure gauge to a working pressure of 1-2 bar.
7. Hold the injection lance in such a way that the soiled injection material is sprayed sideways onto the inside wall of the open container „B“.
8. Run the pump until clean solvent emerges. When using metal containers, ensure that contact is maintained between the injection lance and the wall of the container to avoid electrostatic charging.



To avoid unnecessary loss of injection material, we recommend to spray the remaining material in the hoses back into container „C“ until the first solvent emerges (not applicable for two component materials).

- 9.** Close the injection lance.
- 10.** Turn back the air regulator by turning the the control screw to the left until it moves freely. The pressure gauge must show 0 bar.
- 11.** Close the air tap lock.
- 12.** Re-open the injection lance shortly to release any remaining pressure from the system.

7 Maintenance / Repair

7.1 Checks

According to the rules for the prevention of accidents „Working with liquid jet systems“ BGR 500, Chap. 2.36 the equipment must be checked and overhauled at regular intervals by a specialist (**WIWA**® Service).

The equipment must be checked:

- before the first start-up,
- after changes and repairs of equipment parts having an effect on safety,
- after an interruption of operation of more than 6 months,
- at the latest, every 12 months.

For equipment that has been taken out of operation, the check can be postponed up to the next start-up.

The results of the checks must be recorded in writing and kept until the next check. The checking certificate or a copy of it must be available at the place where the equipment is used.

7.2 Maintenance plan

- Before every start-up check the amount of release agent in the release agent chamber.
Amount to refill:
Fill until lubricant appears in the filling pipe (approx. 1 cm under the opening, approx. 50 ml release agent)
- Check release agent once every 50 operating hours for discoloration due to mixing with injection material.

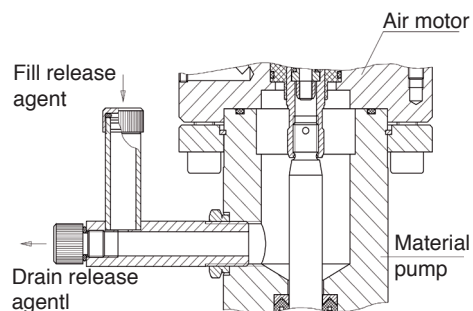

Picture 7.1 Filling and draining release agent

If slightly discolored:

Change the release agent.

By draining a small amount, the degree of discoloration can be observed. Once finished, refill an equal amount of clean release agent to that which was drained.

If heavily discolored and large proportion of spraying material is present:

Clean the release agent chamber, change the upper pump packing (see list of spare parts for material pump) and fill with new release agent. We recommend using **WIWA**® flushing agent, order no.: 0163333.

You will find further maintenance information for each component located in the appendix of each spare parts list.

8 Disturbances during operation and troubleshooting

Faults	Probable Causes	Remedies
1. Pump does not operate, even though the injection lance is triggered..	➤ Lack of compressed air.	➤ Check the inlet air connection.
	➤ Air tap lock is closed.	➤ Open air tap lock.
	➤ Air motor is defect.	➤ Repair the air motor using the spare parts list and Repair Instructions. Packings or valve worn.
	➤ Suction hose or bottom valve is blocked.	➤ Clean the suction hose or replace it
➤ Unscrew the bottom valve and thoroughly clean the ball and valve seat.		
2. Pump operates, but no injection material reaches the orifice of the injection lance..	➤ Suction hose blocked.	➤ Replace the suction hose.
	➤ Bottom valve ball stuck.	➤ Unscrew suction system. Using a pin or a screw driver, release ball in bottom valve from underneath.
		➤ Open injection lance ball valve.
		➤ Knock lightly on the side of the bottom valve with a hammer.
➤ Bottom valve doesn't close.	➤ Unscrew the bottom valve and thoroughly clean the ball and valve seat.	
3. Material exits the orifice, but the pump continues to run when the injection lance is not activated.	➤ Packings or valve worn.	➤ Replace the worn parts.
4. Pump runs evenly, but the necessary injection pressure can not be reached	➤ Air supply pressure too low.	➤ Increase air pressure at air regulator. Check that the diameter of the air line is correct.
	➤ Air motor frozen.	➤ Reduce inbound air pressure if possible, If not included, mount a maintenance unit with oiler. Fill the oiler with anti-freeze and set according to the Instruction Manual: approx. 1 drop every 10 strokes.

Faults	Probable Causes	Remedies
5. Pump cycles unevenly and does not reach the required injection pressure. (The uneven cycling of the pump is recognizable by the difference of the cycling speed of the upward and downward strokes)	➤ The viscosity of the material is too high (suction loss).	➤ Thin down material (add solvent).
	➤ Suction system is not tight (injection stream pulsates).	➤ Use bigger pump.. ➤ Check all seals on fittings of the suction pipe and hose and exchange if necessary.
	➤ Bottom valve is leaking (pump only stops on the upward stroke when the injection gun / lance is closed).	➤ Unscrew bottom valve. Thoroughly clean ball with seat or exchange if necessary.
	➤ Piston valve is leaking (pump only stops on the downward stroke when the injection lance is closed).	➤ Check and clean ball with seat of the dual piston or exchange if necessary
	➤ Upper or lower packing is worn.	➤ Exchange packings.

9 Appendix

9.1 Technical specifications

Model	Injekt-HD 1	Injekt-HD 2	
Order-No.	0644426	0644517	0655848 0660410
Pressure ratio	33:1	33:1 42:1	
Max. free-flow output (ltr/min)	3,0	3,0 2,5	
Output per cycle (ccm)	14	14 11	
Max. input air pressure(bar/psi)	8/116	8/116 8	
Max. operating pressure (bar/psi)	264/3828	264/3828 336/4873	
Material outlet	1/4" NPS(A)	1/4" NPS(A)	
Air inlet	1/4"	1/4"	
Container volume /ltr/gallons)	1,5/0,4	6/1,6	
Approx. dimensions: LxWxH (mm/inch:	595x320x305 23x12,6x12	705x499x340 27,8x19,6x13,4	
Approx. net weight (kg/lbs)	8	9	
Sound pressure level emitted at the work place			
Running at idle (LpAd) (dB)	84		
Running with load (LpAd) (dB)	80		

9.2 Machinery materials

Description	Order No.
Release agent ¹	0163333
Anti freeze ² (0,5l)	0631387
Pneumatik-oil ² (0,5 liter)	0632579
Thread sealant ³ (50 ml / 1.7 fl.oz.)	0000015
Grease () ³ (acid-free, 0,4 kg)	0000025

¹ Softener for filling the release agent chamber of the fluid pump

² for maintenance unit

³ Required for maintenance and/or repairs

9.3 Instruction Certificate

This certificate follows the EC-Directive for working utensils 85/655/EEC, section II article 7.

The owner of the device specified below has instructed the operating personnel.

Manufacture	
Type designation	
Year of construction	
Serial-number	

The instruction was conducted by the representative of the owner:

Foreman or responsible superior, name, department	
---	--

The instructed person has read and understood the user manual for the equipment listed above, especially the chapter about safety, and declares that he is able to operate the unit in a safe way.

Personnel for:	Date, name
Operation	
Repair and maintenance	

9.4 Machine card

This User's Handbook is valid only in connection with the following machine card:

The machine card includes all machine specifications and details which are important and relevant for safety:

- exact designation and manufacturing data
- technical specification and limit values
- equipment and inspection certificate
- details and order numbers for spare parts
- machine features (machine components and accessories supplied with spare parts number)

Please pay attention that the machine card specifications are in accordance with the nameplate. In case of any deviations or if the nameplate is missing, we would ask you to advise us without delay.



because it works

WIWA Service +49 (0)6441 609 140

Headquarters and production

WIWA Wilhelm Wagner GmbH & Co. KG

Gewerbestr. 1-3
35633 Lahnau, Germany
Phone: +49 6441 609-0
Fax: +49 6441 609-50
E-Mail: info@wiwa.de
Homepage: www.wiwa.de

WIWA Partnership USA

WIWA LP

107 N. Main St.
P.O. Box 398, Alger, OH 45812
Phone: +1 (419) 757-0141
Fax: +1 (419) 549-5173
Toll Free: +1(855) 757-0141
E-Mail: jwold@wiwalp.com
Homepage: www.wiwalp.com

WIWA Subsidiary China

WIWA (Taicang) Co., Ltd.

Building A of Huaxin Industrial Park
No.11 East Qingdao Road, Taicang City
Jiangsu Province 215400, P.R.China
Phone: +86 512-5354 8857
Fax: +86 512-5354 8859
E-Mail: info@wiwa-china.com
Homepage: www.wiwa-china.com

WIWA Middle East General Trading LLC

Mohd Farhan Khan
Jebel Ali Industrial 1, Dubai, UAE
Phone: +9714 884 8220
E-Mail: middleeast@wiwa.com

WWW.WIWA.DE